



MANROSE[®]

Product Catalogue

**FAN &
FAN KITS**



Vent-Axia



FAN6844

GENIUS



THE POWER TO CONTROL

Intelligent air movement for a healthy home

- Automatic or customised App settings for installer and home owner
- Ultra quiet bathroom ventilation or heat transfer
- Long life, low energy DC fan operation

100mm fan kit including: back draught shutter, rigid wall duct and hooded grilles.

- Bathroom Extraction
- Home Air Ventilation
- Heat Transfer



FAN6960

BLUE JET



STREAMLINED

Power and energy efficiency for controlled air movement

- Powerful mixed flow jet streaming
- Brushless EC fan motor
- Variable speed drive

150mm fan including: variable speed controller, control cable, plug and lead.

- Compact EC Inline Duct Fan
- High Pressure Airflow Control



FAN5901

100/125mm Auto humidity switching

FAN6051

100/125mm Auto temperature switching

INTELLIVENT



INTELLIGENT

Managed air movement for a healthy home

- Super efficient (8W) DC fan
- Low pressure continuous background ventilation

- Humidity Management or Through Wall Heat Transfer Models

Table of Contents

GUIDELINES FOR EXTRACTION FAN SELECTION	4	THROUGH WALL FAN KITS	
		QUIET Fan Kits	59
REGULATIONS AND STANDARDS	5	GENIUS App Controlled Fan Kits	60
		INTELLIVENT PIR Sensor Fan Kits	60
FAN SELECTION GUIDELINES	7	SELV and Auto Shutter Fan Kits	62
		Standard Fan Kits	64
FAN APPLICATION GUIDELINES	10	WINDOW FANS	
		SELV and Auto Shutter Fans	66
DESIGNED FOR G4 BUILDING CODE & HEALTHY HOMES - BATHROOMS & KITCHENS	13	Standard Fans	68
		WALL FANS	
DESIGNED FOR G4 BUILDING CODE & HEALTHY HOMES - BATHROOMS	22	Internal	70
		External	70
DESIGNED FOR HEALTHY HOMES STANDARD - BATHROOMS & KITCHENS	26	HEATER-FAN-LIGHT SYSTEMS	
		Heater-Fan-Light Systems	72
DESIGNED FOR HEALTHY HOMES STANDARD - BATHROOMS	27	HEAT-FAN-LIGHT SYSTEMS	
		Heat-Fan-Light Systems	74
HIGH BACKGROUND NOISE COMPLIANCE - VENTILATION	30	HEAT-LIGHT SYSTEMS	
		Heat-Light Systems	74
CEILING EXTRACTION FANS - CENTRIFUGAL		THROUGH ROOF FANS	
CONTOUR Centrifugal Fans - G4 Compliant	32	Through Roof Fan Cowl	76
		Through Roof Fan Kits	78
INLINE FANS		Roof Cowl	80
Inline Mixed Flow Fans	34	Roof Cowl Kits	81
Inline Axial Fans	36		
Inline Centrifugal 3 Speed Fans	38	MULTIVENT CONTINUOUS EXTRACT VENTILATION	83
Inline Centrifugal Fans	40		
INLINE EXTRACTION FAN KITS		INLINE EXTRACT FANS - ALASKON	
Inline Extraction Fan Kits - Contour Fascia Selection	42	Centrifugal	84
Inline Extraction Fan Kits without Lights	44	ROOF MOUNTED FANS - ALASKON	
Inline Extraction Fan Kits with LED	46	Axial - Side Discharge	86
Inline Extraction Fan Kits with Halogen Lamp	48	PLATE MOUNTED FANS - ALASKON	
		Axial	87
WALL/CEILING FANS		FRAME FANS	
QUIET Fans	51	Axial	88
Cucina Fan	52	ACCESSORIES	89
Eco Fan	53		
SELV and Auto Shutter Fans	54		
Standard Fans	56		

RECOMMENDED MANROSE[®] EXTRACTION PRODUCTS FOR POTENTIAL APPLICATIONS

There are four different levels of regulations and/or acceptable solutions for residential Bathrooms and Kitchens in New Zealand. These cascade down, in the table below, from the highest performance standard at the top, to the lowest at the bottom.

These standards are explained on the following pages. It is important to note that the Manrose product recommendations are guidelines, and responsibility for compliance remains with the installer, as the performance of the complete system is dependent on the quality of the installation practice used and is specific to each site. Manrose product packaging for these applications carries one of the four blue stamps shown below.

SEE PAGE
13-21



DESIGNED FOR G4 BUILDING CODE & HEALTHY HOMES
– BATHROOMS & KITCHENS

SEE PAGE
22-25



DESIGNED FOR G4 BUILDING CODE & HEALTHY HOMES
– BATHROOMS

SEE PAGE
26



DESIGNED FOR HEALTHY HOMES STANDARD
- BATHROOMS & KITCHENS

SEE PAGE
27-29



DESIGNED FOR HEALTHY HOMES STANDARD
- BATHROOMS

Regulations and Standards

New Zealand Building Code and Healthy Homes

The following two category requirements have been established for mandatory mechanical extraction ventilation in New Zealand.

The New Zealand Building Code for New Building Consents

The building regulatory system sets out a framework to promote good quality decisions being made during the Building Consent process. The legislation and regulations work together, as the building regulatory system. The functional clauses of the NZ Building Code are grouped and described by a letter and number. Clause G of the NZ Building Code covers services, with G4 setting out the performance requirements for ventilation. The Building Code is enshrined in law. The New Zealand Building Code, G4, has been changed. This is supported by Acceptable Solution G4/AS1 Fourth Edition that specifies mechanical ventilation in accommodation units that contain cooktops, showers and baths.

Residential Tenancy Regulations to the Healthy Homes Standards

Residential Tenancy Regulations for rental properties only has changed to the Healthy Homes Standards, sub part 4 - Ventilation Standards.

Complying with the Acceptable Solution G4/AS1

To comply, the mandatory mechanical extract system must deliver minimum airflow rates for the complete installed ventilation system. This means that airflow rates must deliver the airflow after resistance of the ducting, internal and external grilles, as well as all other accessories, such as backdraught shutters, are included.

Fan selection is important as some types are far better at overcoming ducting system pressure drops.

Additionally, the quality of the ducting system installation can be all important. Rigid duct systems (see page 125) are best as they are the most efficient. Good installation practice is vital for flexible duct systems.

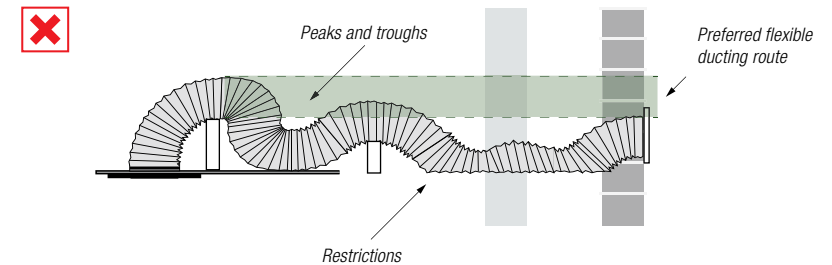
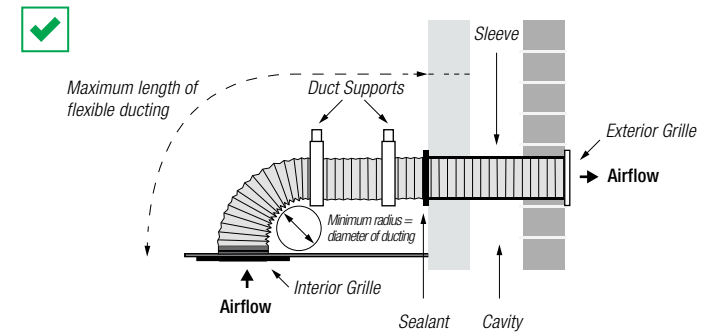

Regulations and Standards

Choosing the Right Fan to Comply

Fans cannot be selected on the basis of free-air performance only. Fans must now be selected on the basis of the complete installed system performance for a designated room as per the table below.

Room	Airflow Rate (min.)	
	Intermittent	Continuous
Toilet ¹⁾	25 l/s	10 l/s
Bathroom/shower	25 l/s	10 l/s
Laundry ²⁾	40 l/s	-
Kitchen	50 l/s	12 l/s

1) Toilets only require ventilation if they have no openable windows

2) Simx recommends 40 l/s for laundries with unvented non-condensing tumble dryers as covered in AS 1668: Part 2 2012

With earlier unregulated extract fan practices in New Zealand, the market trended to basic, low pressure axial fan products, as installed system performance was not defined for independent inspection testing and compliance signed off by local authorities. This approach has changed under the latest mandatory regulations.

Fan Type Considerations

Determining the best fan requires consideration of location, sound levels and aesthetic appeal. Different fans suit different applications. The longer the duct run, the greater the pressure that is required to overcome the resistance created by the duct. Low pressure is required for short run systems, such as through wall or window mounted fans, but far greater pressure is required for longer ducted systems and where the fan and ducting, with more bends, is installed in the roof cavity.

Short Run Systems

As through wall and window mounted axial fans only have to extract air over a short distance, the installed system performance rates are only slightly lower than that of fan's free-air performance rate. Fan selection to ensure compliance for any room requirement is, therefore, a straightforward procedure. See page 9 for further information.

Ducted Systems

The best solutions for ducted systems are centrifugal and mixed flow fans. These types of extraction fans are designed to develop the necessary pressure and resilience to overcome duct and grille system pressure-drop resistance. Axial inline fans are suitable for shorter duct runs, but will not be very forgiving when it comes to installation so care must be taken to ensure the best practice guidelines are followed.

Installed performance of a fan can, however, vary greatly dependent on the location, length of duct, number of bends and fittings such as backdraught shutters, cowls and grilles. For complete installed system performances to meet the standards, the following guidelines may be used as application limits dependent on *best practice* duct installation being employed along with the use of airflow efficient accessories such as grilles and backdraught shutters.

Fan Selection Guidelines

Ceiling Extraction Fans - Manrose Contour Centrifugal Range

The new Manrose CONTOUR range of centrifugal fans offers model options that easily exceed the **New Zealand Building Code G4/AS1** requirements for that specific room installation. To make it even easier for correct product selection, Manrose Contour fans are identified by their intended application purpose.

Selection Reference Guide

Toilet	Manrose Contour Toilet fan - FAN7030
Bathroom	Manrose Contour Bathroom fan - FAN7031
Laundry	Manrose Contour Kitchen and Laundry fan - FAN7032
Kitchen	Manrose Contour Kitchen and Laundry fan - FAN7032

Further, the Manrose CONTOUR fan range also includes the CONTOUR High Steam Area Fans (FAN7033 & FAN7034) for the more demanding applications and/or complete performance peace-of-mind. See page 9 for details.

Toilet

25 l/s

		Metres of Ducting									
		1	2	3	4	5	6	7	8	9	10
No. of Bends	1	✓	✓	✓	✓	✓	✓	✓	✓	✓	✓
	2	✓	✓	✓	✓	✓	✓	✓	✓	✓	✓
	3	✓	✓	✓	✓	✓	✓	✓	✓	✓	✓
	4	✓	✓	✓	✓	✓	✓	✓	✓	✓	✓
	5	✓	✓	✓	✓	✓	✓	✓	✓	✓	✓

Toilets only require ventilation if they have no openable windows

Bathroom

25 l/s

		Metres of Ducting									
		1	2	3	4	5	6	7	8	9	10
No. of Bends	1	✓	✓	✓	✓	✓	✓	✓	✓	✓	✓
	2	✓	✓	✓	✓	✓	✓	✓	✓	✓	✓
	3	✓	✓	✓	✓	✓	✓	✓	✓	✓	✓
	4	✓	✓	✓	✓	✓	✓	✓	✓	✓	✓
	5	✓	✓	✓	✓	✓	✓	✓	✓	✓	✓

Laundry

40 l/s

		Metres of Ducting									
		1	2	3	4	5	6	7	8	9	10
No. of Bends	1	✓	✓	✓	✓	✓	✓	✓	✓	✓	✓
	2	✓	✓	✓	✓	✓	✓	✓	✓	✓	✓
	3	✓	✓	✓	✓	✓	✓	✓	✓	✓	✓
	4	✓	✓	✓	✓	✓	✓	✓	✓	✓	✓
	5	✓	✓	✓	✓	✓	✓	✓	✓	✓	✓

Simx recommends 40 l/s for laundries with unvented non-condensing tumble dryers

Kitchen

50 l/s

		Metres of Ducting									
		1	2	3	4	5	6	7	8	9	10
No. of Bends	1	✓	✓	✓	✓	✓	✓	✓	✓	✓	✓
	2	✓	✓	✓	✓	✓	✓	✓	✓	✓	✓
	3	✓	✓	✓	✓	✓	✓	✓	✓	✓	✓
	4	✓	✓	✓	✓	✓	✓	✓	✓	✓	✓
	5	✓	✓	✓	✓	✓	✓	✓	✓	✓	✓



Fan Selection

- Contour Toilet - FAN7030
- Contour Bathroom - FAN7031
- Contour Kitchen & Laundry - FAN7032

Fan Selection Guidelines

Inline Extraction Fans

The following chart provides easy fan selection guidelines, if good ducting system selection and installation best practices have been employed. This is to ensure compliance with the building code. An upgrade to the next available model is always recommended for higher airflow rates and more complex installations. These are guideline recommendations to assist with fan selection for NZBC G4/AS1 compliance.

Selection Reference Guide

Toilet	Manrose Hyper150 EC axial fan for simple runs Manrose Mixflo 150 mixed flow fan for longer runs
Bathroom	Manrose Hyper150 EC axial fan for simple runs Manrose Mixflo 150 mixed flow fan for longer runs
Laundry	Manrose Mixflo 150 axial fan
Kitchen	Manrose Mixflo 150 or Manrose Blue Jet mixed flow fans for best efficiency/airflow or on long ducts

Toilet 25 l/s

		Metres of Ducting									
		1	2	3	4	5	6	7	8	9	10
No. of Bends	1	[Color-coded grid]									
	2										
	3										
	4										
	5										

Toilets only require ventilation if they have no openable windows

Bathroom 25 l/s

		Metres of Ducting									
		1	2	3	4	5	6	7	8	9	10
No. of Bends	1	[Color-coded grid]									
	2										
	3										
	4										
	5										

Laundry 40 l/s

		Metres of Ducting									
		1	2	3	4	5	6	7	8	9	10
No. of Bends	1	[Color-coded grid]									
	2										
	3										
	4										
	5										

Simx recommends 40 l/s for laundries with unvented non-condensing tumble dryers

Kitchen 50 l/s

		Metres of Ducting									
		1	2	3	4	5	6	7	8	9	10
No. of Bends	1	[Color-coded grid]									
	2										
	3										
	4										
	5										

Fan Selection

- Hyper150 EC
- Mixflo 150
- Blue Jet

Fan Selection Guidelines

Through Wall and Window Fans

The through wall and window fans listed in the following sections provide an easy fan selection guideline for Manrose through wall or window fans designed for the **New Zealand Building Code G4 Acceptable Solution** when best practice duct system selection and installation is used. An upgrade higher pressure and free-air performance is always recommended for better results.

Fan Models with Simple Selection Reference Guidelines - to be used in conjunction with the following pages

Toilet	125mm fan	Bathroom	125mm fan	Laundry	150mm fan
	150mm fan		150mm fan	Kitchen	150mm fan

Healthy Home Compliance - for Residential Tenancies rental properties only

Application	Wall/Ceiling Fans			Through Wall Fan Kits			Window Fans	
	Designer	Pro-Series	Classic	Designer	Pro-Series	Classic	Classic	
Toilet	150mm	FAN7183	FAN0594	FAN0120	FAN7190	FAN0621	FAN0135	FAN0107
	125mm	FAN7180	FAN0589	FAN0072	FAN7187	FAN0614	FAN0080	-
Bathroom	150mm	FAN7183	FAN0594	FAN0120	FAN7190	FAN0621	FAN0135	FAN0107
	125mm	FAN7180	FAN0589	FAN0072	FAN7187	FAN0614	FAN0080	-
Laundry	150mm	FAN7183	FAN0594	FAN0120	FAN7190	FAN0621	FAN0135	FAN0107
Kitchen	150mm	FAN7183	FAN0594	FAN0120	FAN7190	FAN0621	FAN0135	FAN0107

Continuous Ventilation

As an alternative to the traditional intermittent fans, the products shown below can be set as continuous running fans which provide a low level of trickle ventilation which runs constantly. These fans then have a boost facility via manual or automatic operation. These fans provide the most energy efficient and comfortable form of ventilation with low noise and excellent indoor air quality.



Filtered Passive Ventilation

The Puro Filtered Passive Vent Kit DCT4565 is recommended for use in conjunction with Manrose and Vent-Axia extract fans to deliver improved indoor air quality. This is especially recommended with the continuously operating fans above.



Fan Application Guidelines

1. Calculate the Room Size

- Calculate the room volume in cubic metres (L x W x H) e.g. 2.8m x 2.6m x 2.4m = 17.47m³.
- Multiply the room volume by the following guidelines for air changes per hour (ACH) for that room. Always use the higher limit.

Toilets	6-10 ACH
Bathrooms, showers, ensuites	11-15 ACH
Kitchens, laundries	15-20 ACH

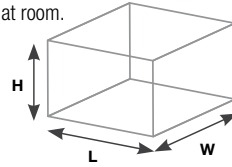

- The result is the minimum airflow performance required in cubic metres per hour that can be assessed against the fans Free Air Fan Performance, listed on the following pages, after a large downgrading allowance is made for the considerable slowing effect of a complete installed system. See page 6 for a description of duct system losses that will also occur from fascias, grilles, cowls and backdraft shutters. Manrose technical support can be consulted for their recommendations.

2. Consider the Location in the Room

The right placement of an extraction fan will ensure optimum airflow through the bathroom. To ensure the fan works to its maximum efficiency, the extracted air needs to be replenished, or “made up”, with an equal amount of dry air drawn in from an adjacent room or hallway. This make-up air replenishment may be assisted with the installation of a door grille (FAN0159).

Poor Circulation

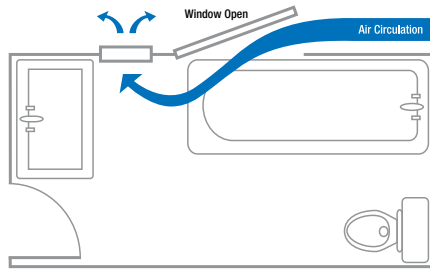

Medium Circulation

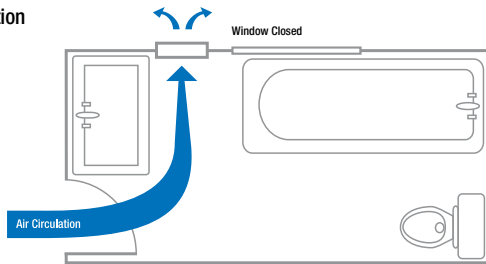

Best Circulation

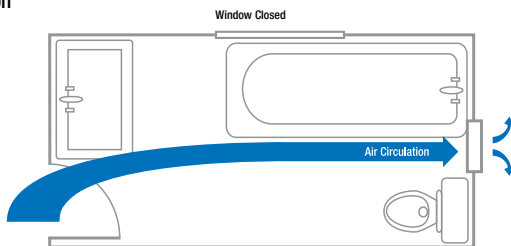

Fan Application Guidelines

3. Wet Area Zones & Recommended Fan Types

Wet area zones are determined by their proximity to the bath or shower. Use the wet area zone plan and table to identify what type of fan is required.

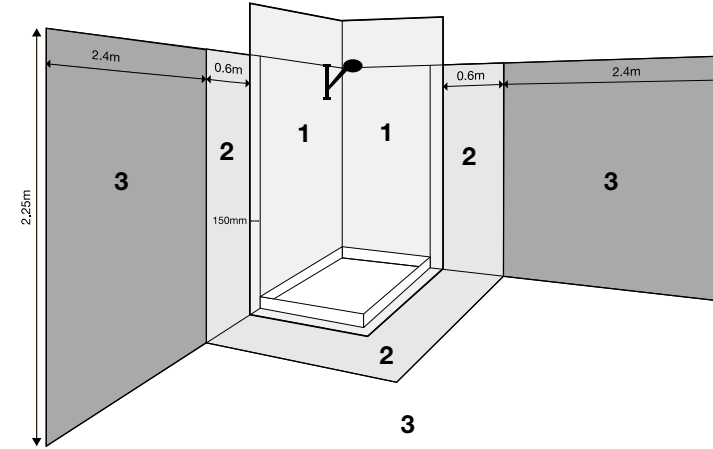

Zone	Description	Recommended Fan Type
1	Area immediately above the bath or shower tray up to the higher of either 2.25m or the height of the fixed plumbing connection	Safety extra low voltage fans, inline fans, or Contour fans & fascias only
2	Area within 0.6m around the edge of the bath or shower tray	Any fan
3	Any area outside Wet Area Zones 1 & 2	Any fan





Fan Application Guidelines

4. Select a Fan Type

From the list below select a fan type, then see the following sections to identify the model you require. Ensure the model you select has a performance (m³/h) greater than the performance calculated in Step 1.

Fan Type	Application	Key
Inline Extraction Fans	Wet area zone 1	
Wall/Ceiling Fans	Wall and ceiling	
Heat-Fan-Light Systems	Ceiling, multi-function	
Inline Extraction Fan Kits	Wet area zone 1, integrated light	
Through Wall Fan Kits	Wall	
Through Roof Fan Kits	Roof	
Safety Extra Low Voltage (SELV)	Wet area zone 1	
Window Fans	Window	



5. Saving Energy

The best way of calculating the most energy efficient fan for your needs, is to compare the specific fan powers of each one selected. The fan with the lower watts per l/s, will use less energy. If a fan has similar specific fan power to another, but much higher pressure for ducted installations, it will still be the more efficient option.

Max. Fan Watts (W)	Max. Fan Pressure (Pa)	Free Air Fan Performance (l/s)	Free Air Fan Performance (m ³ /hr)	Specific Fan Power (W/l/s)	Sound dB(A)
25	60	101	364	0.25	40
20	35	36	130	0.56	41

6. Fan Switching Options

Option	Description
Standard	Remote wall switch
Timer	Remote switch with delayed OFF adjustable from 1-20 minutes
Pull Cord	Integral pull cord switch on fan
PIR Control	Motion sensor incorporated in fan
Auto Sense	Condition sensor incorporated in fan
Variable Speed Controller	Incorporated speed drive in fan
Humidity Automation	Humidity sensing and control incorporated in fan

DESIGNED FOR G4 BUILDING CODE & HEALTHY HOMES – BATHROOMS & KITCHENS

Extraction Fans - Centrifugal

CONTOUR fans deliver simple compliance with current New Zealand Building Code G4/AS1 mandatory mechanical extract ventilation system requirements. As well as providing application room specific performance, Contour **Kitchen** and **Laundry** fans have a comprehensive range of stylish, interchangeable fascia to choose from.

CONTOUR Kitchen and Laundry Fan	Duct (mm)	Fan Type	Max. Fan Watts (W)	Max. Fan Pressure (Pa)	Free Air Fan Performance		Specific Fan Power (W/l/s)	Sound dB(A)	Fascia	Switching	Product Code
					(l/s)	(m ³ /hr)					
	150	Centrifugal	50	210	105	378	0.48	42	Range Selection (see below)	Standard	FAN7032

CONTOUR High Steam Area Fan	Duct (mm)	Fan Type	Max. Fan Watts (W)	Max. Fan Pressure (Pa)	Free Air Fan Performance		Specific Fan Power (W/l/s)	Sound dB(A)	Fascia	Switching	Product Code
					(l/s)	(m ³ /hr)					
	150	Centrifuga	106	220	153	550	0.69	42	Round White	Standard	FAN7033
									Square White	Standard	FAN7034

Fascia Selections

Fan	Round				Square			
	White	Black	LED White	LED Black	White	Black	LED White	LED Black
Kitchen and Laundry	DCT4510	DCT4511	DCT4514	DCT4515	DCT4512	DCT4513	DCT4516	DCT4517

Inline Fans - Centrifugal 3 Speed

Centrifugal fans create high pressure airflows and are best suited for high pressure applications such as drying and air conditioning systems. Suitable for a variety of domestic applications, these inline centrifugal 3 speed fans provide high performance at your pre-set choice of speed and can also be used for supply. 2 year warranty.

WhisperVent 3 Speed	Duct (mm)	Fan Type	Max. Fan Watts (W)	Max. Fan Pressure (Pa)	Free Air Fan Performance		Specific Fan Power (W/l/s)	Sound dB(A)	Switching	Product Code	
					(l/s)	(m ³ /hr)					
	150		Speed 1	41	225	86	310	0.48	30	Standard	FAN0830
			Speed 2	46	296	122	440	0.38	36		
			Speed 3	57	356	149	535	0.34	43		





DESIGNED FOR G4 BUILDING CODE & HEALTHY HOMES – BATHROOMS & KITCHENS



Inline Fans - Mixed Flow



The Blue Jet fan incorporates powerful jet streaming technology and is driven by the energy efficient, brushless EC motor to deliver best-in-class airflow performance. A surface mounted variable speed control, and 10m control cable, is supplied along with a plug and lead for the fan. The Blue Jet fan is suitable for all residential applications. 5 year warranty.

The powerful MixFlo fans have been designed to produce higher working pressures for applications that require higher airflows with low relative noise levels. These large bore fans are designed for use with both rigid and flexible ducting. They offer two and half times the pressure of conventional axial fans and are dimensionally more compact making them ideal for many ducted applications. The impeller blade design with guide vanes provides optimum pressure characteristics. The fan can operate in both horizontal and vertical positions. Supported by a 4 year warranty or 30,000 continuous hours.

Designer BLUE JET	Duct (mm)	Fan Type	Max. Fan Watts (W)	Max. Fan Pressure (Pa)	Free Air Fan Performance		Specific Fan Power (W/l/s)	Sound dB(A)	Switching	Product Code
					(l/s)	(m ³ /hr)				
	150	EC Mixed Flow	40	490	165	594	0.24	60	Variable Speed Controller	FAN6960
Pro-Series MIXFLO 2 Speed	Duct (mm)	Fan Type	Max. Fan Watts (W)	Max. Fan Pressure (Pa)	Free Air Fan Performance		Specific Fan Power (W/l/s)	Sound dB(A)	Switching	Product Code
					(l/s)	(m ³ /hr)				
	150	Mixed Flow	70 60	300 240	166 92	597 330	0.42 0.65	47 40	Standard Plug & Lead	FAN1006 FAN1048

Inline Fans - Axial

Axial fans create low pressure high volume airflows and are best suited for general purpose applications. The Hyper150 EC axial fan is the trusted leader in bathroom extraction. Now with an EC motor, other ongoing improvements and variable speed control with 10m control cable, Hyper150 continues to lead the field. 7 year warranty.

Classic HYPER150 EC	Duct (mm)	Fan Type	Max. Fan Watts (W)	Max. Fan Pressure (Pa)	Free Air Fan Performance		Specific Fan Power (W/l/s)	Sound dB(A)	Switching	Product Code
					(l/s)	(m ³ /hr)				
	150	EC Axial	18	91	105	380	0.17	38	Standard	FAN0085
	150	EC Axial	18	91	105	380	0.17	38	Variable Speed Controller**	FAN7000*

*All data for FAN7000 at full speed

** Euro flush-box for variable speed control switch – included

DESIGNED FOR G4 BUILDING CODE & HEALTHY HOMES – BATHROOMS & KITCHENS



Inline Extraction Fan Kits - Hyper150 EC Contour Fascia-ready Kit

Kits are designed so the fascia-fitted adapter plate can be mounted directly above the steam source (eg: shower or bath). The adapter plate can be finished in style with a choice of separately ordered fascia from a comprehensive range of interchangeable round and square fascia options in either black or white (with or without 10W LED). 7 year warranty.

Designer Standard Profile	Duct (mm)	Fan Type	Max. Fan Watts (W)	Max. Fan Pressure (Pa)	Free Air Fan Performance		Specific Fan Power (W/l/s)	Fascia	Exterior Grille	Switching	Product Code
					(l/s)	(m ³ /hr)					
	150	EC Axial	18	91	105	380	0.17	Range Selection (see below)	White Fixed Louvre	Standard	FAN7044

Inline Extraction Fans Kits - MixFlo Contour Fascia-ready Kit

Kits are designed so the fascia-fitted adapter plate can be mounted directly above the steam source (eg: shower or bath). The adapter plate can be finished in style with a choice of separately ordered fascia from a comprehensive range of interchangeable round and square fascia options in either black or white (with or without 10W LED). 5 year warranty.

Designer Standard Profile	Duct (mm)	Fan Type	Max. Fan Watts (W)	Max. Fan Pressure (Pa)	Free Air Fan Performance		Specific Fan Power (W/l/s)	Fascia	Exterior Grille	Switching	Product Code
					(l/s)	(m ³ /hr)					
	150	Mixed Flow	70 60	300 240	166 92	597 330	0.42 0.65	Range Selection (see below)	White Fixed Louvre	Standard	FAN7366

Fascia Selections (order separately)

Round				Square			
White	Black	LED White	LED Black	White	Black	LED White	LED Black
							
DCT4502	DCT4503	DCT4506	DCT4507	DCT4504	DCT4505	DCT4508	DCT4509



DESIGNED FOR G4 BUILDING CODE & HEALTHY HOMES – BATHROOMS & KITCHENS



Inline Extraction Fan Kits without Lights

These kits are designed so that the interior grille can be mounted directly above your steam source (eg: shower or bath). Kits with the low profile fascia are supplied with a choice of stylish grilles. Mixed flow fans provide users with a two fan speed option. 5 year warranty.

Pro-Series Low Profile	Duct (mm)	Fan Type	Max. Fan Watts (W)	Max. Fan Pressure (Pa)	Free Air Fan Performance		Specific Fan Power (W/l/s)	Fascia	Exterior Grille	Switching	Product Code
					(l/s)	(m ³ /hr)					
	150	Mixed Flow	70	300	166	597	0.42	Round White	Weatherproof Cowl White and Fixed Louvre White	Standard	FAN2051
					92	330					
	150	EC Axial	18	91	105	380	0.17	Round White and Square White	Weatherproof Cowl White and Fixed Louvre White	Standard	FAN0618
										Timer	FAN0619
Classic Standard Profile	Duct (mm)	Fan Type	Max. Fan Watts (W)	Max. Fan Pressure (Pa)	Free Air Fan Performance		Specific Fan Power (W/l/s)	Fascia	Exterior Grille	Switching	Product Code
					(l/s)	(m ³ /hr)					
	150	EC Axial	18	91	105	380	0.17	Round White	Fixed Louvre White	Standard	FAN0101
										Timer	FAN0102

Inline Extraction Fan Kits with LED Lights

These high efficiency inline fans are designed to provide higher levels of extraction for larger bathrooms and the LED light adds light directly above your steam source (eg: shower or bath). 5 year warranty.

Classic Standard Profile	Duct (mm)	Fan Type	Max. Fan Watts (W)	Max. Fan Pressure (Pa)	Free Air Fan Performance		Specific Fan Power (W/l/s)	Fascia	Exterior Grille	Switching	Product Code
					(l/s)	(m ³ /hr)					
	150	EC Axial	18	91	105	380	0.17	Round White	Eggcrate White	Standard	FAN5369
										Timer	FAN5370

Inline Extraction Fan Kits with Halogen Lights

These high efficiency inline fans are designed to provide higher levels of extraction for larger bathrooms and the halogen light adds light directly above your steam source (eg: shower or bath). 5 year warranty.

Classic Standard Profile	Duct (mm)	Fan Type	Max. Fan Watts (W)	Max. Fan Pressure (Pa)	Free Air Fan Performance		Specific Fan Power (W/l/s)	Fascia	Exterior Grille	Switching	Product Code
					(l/s)	(m ³ /hr)					
	150	EC Axial	18	91	105	380	0.17	Round White	Eggcrate White	Standard	FAN0803
										Timer	FAN0804

DESIGNED FOR G4 BUILDING CODE & HEALTHY HOMES – BATHROOMS & KITCHENS



Extraction Fans - THROUGH WALL MOUNTED ONLY

These axial fans are designed for easy installation, low running noise and efficient operation. SELV (safety extra low voltage) fans are for use in wet area zones 1, 2 and 3 and incorporate a 12V AC motor and a 12V AC isolating transformer. Auto shutter models have automated backflow prevention vanes. 5 year warranty.

The new high-pressure and energy-efficient QUIET fans have ultra-high airflow with no nuisance noise and are designed to be ducted straight through a bathroom or kitchen exterior wall. 5 year warranty.

Safety Extra Low Voltage (SELV)

Pro-Series Low Profile	Duct (mm)	Fan Type	Max. Fan Watts (W)	Max. Fan Pressure (Pa)	Free Air Fan Performance		Specific Fan Power (W/l/s)	Sound dB(A)	Fascia	Switching	Product Code
					(l/s)	(m ³ /hr)					
	150	Axial	20	60	101	364	0.20	40	Square	Standard	FAN5892
									Round	Standard	FAN5891
Classic Standard Profile	Duct (mm)	Fan Type	Max. Fan Watts (W)	Max. Fan Pressure (Pa)	Free Air Fan Performance		Specific Fan Power (W/l/s)	Sound dB(A)	Fascia	Switching	Product Code
					(l/s)	(m ³ /hr)					
	150	Axial	20	60	101	364	0.20	40	Square	Standard	FAN5896

Auto Shutter

Classic Standard Profile	Duct (mm)	Fan Type	Max. Fan Watts (W)	Max. Fan Pressure (Pa)	Free Air Fan Performance		Specific Fan Power (W/l/s)	Sound dB(A)	Fascia	Switching	Product Code
					(l/s)	(m ³ /hr)					
	150	Axial	25	60	87	313	0.29	40	Square	Standard	FAN0121
										Pull Cord	FAN0122
										Timer	FAN0123

Standard

Designer QUIET	Duct (mm)	Fan Type	Max. Fan Watts (W)	Max. Fan Pressure (Pa)	Free Air Fan Performance		Specific Fan Power (W/l/s)	Sound dB(A)	Fascia	Switching	Product Code
					(l/s)	(m ³ /hr)					
	150	Axial	22	138	114	410	0.19	41	Square	Standard	FAN7183
										Timer	FAN7184
										Humidity Control	FAN7185
Pro-Series Low Profile	Duct (mm)	Fan Type	Max. Fan Watts (W)	Max. Fan Pressure (Pa)	Free Air Fan Performance		Specific Fan Power (W/l/s)	Sound dB(A)	Fascia	Switching	Product Code
					(l/s)	(m ³ /hr)					
	150	Axial	20	60	101	364	0.20	40	Square	Standard	FAN0594
									Timer	FAN0595	
									Round	Standard	FAN0609
										Timer	FAN0610
Classic Standard Profile	Duct (mm)	Fan Type	Max. Fan Watts (W)	Max. Fan Pressure (Pa)	Free Air Fan Performance		Specific Fan Power (W/l/s)	Sound dB(A)	Fascia	Switching	Product Code
					(l/s)	(m ³ /hr)					
	150	Axial	25	60	101	364	0.25	40	Square	Standard	FAN0120
										Pull Cord	FAN0126
										Timer	FAN0127
										PIR Control	FAN0124







DESIGNED FOR G4 BUILDING CODE & HEALTHY HOMES – BATHROOMS & KITCHENS



Through Wall Fan Kits

These axial fan kits are easy to install and are designed to be ducted straight through an exterior wall. SELV (safety extra low voltage) fans are for use in wet area zones 1, 2 and 3 and incorporate a 12V AC motor and a 12V AC isolating transformer. Auto shutter models have automated backflow prevention vanes. All kits include a weatherproof cowl. 5 year warranty.

The new high-pressure and energy-efficient QUIET fan kits have ultra-high airflow without nuisance noise and are designed to be ducted straight through a bathroom or kitchen exterior wall. All kits include a weatherproof cowl. 5 year warranty.

Safety Extra Low Voltage (SELV)											
Pro-Series Low Profile	Duct (mm)	Fan Type	Max. Fan Watts (W)	Max. Fan Pressure (Pa)	Free Air Fan Performance		Specific Fan Power (W/l/s)	Sound dB(A)	Fascia	Switching	Product Code
					(l/s)	(m³/hr)					
	150	Axial	20	60	101	364	0.20	40	Square	Standard	FAN5894
										Round	FAN5893
Classic Standard Profile	Duct (mm)	Fan Type	Max. Fan Watts (W)	Max. Fan Pressure (Pa)	Free Air Fan Performance		Specific Fan Power (W/l/s)	Sound dB(A)	Fascia	Switching	Product Code
	150	Axial	20	60	101	364	0.20	40	Square	Standard	FAN5895
Auto Shutter											
Classic Standard Profile	Duct (mm)	Fan Type	Max. Fan Watts (W)	Max. Fan Pressure (Pa)	Free Air Fan Performance		Specific Fan Power (W/l/s)	Sound dB(A)	Fascia	Switching	Product Code
	150	Axial	25	60	87	313	0.29	40	Square	Standard	FAN0136
										Pull Cord	FAN0137
										Timer	FAN0138
Standard											
Designer QUIET	Duct (mm)	Fan Type	Max. Fan Watts (W)	Max. Fan Pressure (Pa)	Free Air Fan Performance		Specific Fan Power (W/l/s)	Sound dB(A)	Fascia	Switching	Product Code
	150	Axial	22	138	114	410	0.19	41	Square	Standard	FAN7190
										Timer	FAN7191
										Humidity Control	FAN7192
Pro-Series Low Profile	Duct (mm)	Fan Type	Max. Fan Watts (W)	Max. Fan Pressure (Pa)	Free Air Fan Performance		Specific Fan Power (W/l/s)	Sound dB(A)	Fascia	Switching	Product Code
	150	Axial	20	60	101	364	0.20	40	Square	Standard	FAN0621
										Timer	FAN0623
Classic Standard Profile	Duct (mm)	Fan Type	Max. Fan Watts (W)	Max. Fan Pressure (Pa)	Free Air Fan Performance		Specific Fan Power (W/l/s)	Sound dB(A)	Fascia	Switching	Product Code
	150	Axial	25	60	101	364	0.25	40	Square	Standard	FAN0135
										Pull Cord	FAN0140
										Timer	FAN0141

DESIGNED FOR G4 BUILDING CODE & HEALTHY HOMES – BATHROOMS & KITCHENS



Through Wall Fan Kits

These axial fans are designed for installation situations where an existing window fan is being replaced or where there is no available external wall, or ceiling, space access. SELV fans are designed for use in wet area zones 1, 2 and 3 and incorporate a 12V AC motor and a 12V AC isolating transformer. Auto shutter models have automated backflow prevention vanes. 5 year warranty.

Safety Extra Low Voltage (SELV) & Auto Shutter											
Classic Standard Profile	Duct (mm)	Fan Type	Max. Fan Watts (W)	Max. Fan Pressure (Pa)	Free Air Fan Performance		Specific Fan Power (W/l/s)	Sound dB(A)	Fascia	Switching	Product Code
					(l/s)	(m³/hr)					
	150	Axial	25	60	87	313	0.29	40	Square	Pull Cord	FAN5897
Auto Shutter											
Classic Standard Profile	Duct (mm)	Fan Type	Max. Fan Watts (W)	Max. Fan Pressure (Pa)	Free Air Fan Performance		Specific Fan Power (W/l/s)	Sound dB(A)	Fascia	Switching	Product Code
	150	Axial	25	60	87	313	0.29	40	Square	Pull Cord	FAN0107
										Pull Cord Timer	FAN0109

Kitchen Fans

CUCINA is a powerful 2 boost speed centrifugal extraction fan with a washable metal grease filter. The installation selectable speeds are suitable for kitchens (high speed) or laundries (medium). The fan is G4 and Healthy Homes compliant for kitchen extract ventilation levels (when installed in through wall applications at kitchen boost level) and also has a low speed for long term trickle ventilation. A plate fascia and fine filter kit is also available as a front grille alternative for laundry installations.

Designer CUCINA	Duct (mm)	Fan Type	Fan Speed and Application		Max. Fan Watts (W)	Max. Fan Pressure (Pa)	Free Air Fan Performance		Specific Fan Power (W/l/s)	Sound dB(A)	Switching	Product Code
							(l/s)	(m³/hr)				
	100	Centrifugal	High	Kitchen	60	236	73	263	0.82	52	Pull Cord	FAN7201
			Medium	Laundry								
Plate Fascia and Fine Filter Kit (order separately)											DCT4529	
Replacement Washable Metal Grease Filter (order separately)											DCT4562	





DESIGNED FOR G4 BUILDING CODE & HEALTHY HOMES – BATHROOMS & KITCHENS

Through Roof Fan Cowl and Through Roof Fan Kits

High quality aluminium cowl construction with fan incorporated. 2 year warranty.

Through Roof Fan Cows - Air Extraction

Classic	Duct (mm)	Fan Type	Max. Fan Watts (W)	Max. Fan Pressure (Pa)	Free Air Fan Performance		Specific Fan Power (W/l/s)	Sound dB(A)	Switching	Product Code
					(l/s)	(m ³ /hr)				
	150	Centrifugal	70	320	153	550	0.46	62	Standard	FAN0529
		Centrifugal 3-Speed	70	320	153	550	0.46	62	Standard	FAN1002
		EC Axial	18	91	105	380	0.17	38	Standard	FAN0531

Through Roof Fan Kits with Flashing & HDPE Tube - Air Extraction

Classic	Duct (mm)	Fan Type	Max. Fan Watts (W)	Max. Fan Pressure (Pa)	Free Air Fan Performance		Specific Fan Power (W/l/s)	Sound dB(A)	Switching	Product Code
					(l/s)	(m ³ /hr)				
	150	Centrifugal	70	320	153	550	0.46	62	Standard	FAN0530
		Centrifugal 3-Speed	70	320	153	550	0.46	62	Standard	FAN0967
		EC Axial	18	91	105	380	0.17	38	Standard	FAN1060 FAN0532

Through Roof Fan Heavy Duty Kits with Flashing & HDPE Tube - Air Extraction

Classic	Duct (mm)	Fan Type	Max. Fan Watts (W)	Max. Fan Pressure (Pa)	Free Air Fan Performance		Specific Fan Power (W/l/s)	Sound dB(A)	Switching	Product Code
					(l/s)	(m ³ /hr)				
	150	Centrifugal	70	320	153	550	0.46	62	Standard	FAN0740
	150	EC Axial	18	91	105	380	0.17	38	Standard	FAN0739

Through Roof Fan Kits with Flashing for Metal Based Roof - Air Extraction

Classic	Duct (mm)	Fan Type	Max. Fan Watts (W)	Max. Fan Pressure (Pa)	Free Air Fan Performance		Specific Fan Power (W/l/s)	Sound dB(A)	Switching	Product Code
					(l/s)	(m ³ /hr)				
	150	Centrifugal	70	320	153	550	0.46	62	Standard	FAN0535
		EC Axial	18	91	105	380	0.17	38	Standard	DCT0189



DESIGNED FOR G4 BUILDING CODE & HEALTHY HOMES – BATHROOMS & KITCHENS

External Wall Fans

External wall fans are designed for use in residential and light commercial applications where a high performance, low noise solution is required. Three speed models enable further flexibility in a variety of applications. Specific applications include apartments where space is limited.

Standard

Classic	Duct (mm)	Fan Type	Scroll Dia. (mm)	Max. Fan Watts (W)	Max. Fan Pressure (Pa)	Free Air Fan Performance		Specific Fan Power (W/l/s)	Sound dB(A)	Switching	Product Code
						(l/s)	(m ³ /hr)				
	150	Axial	-	48	80	73	263	0.66	48	Standard	FAN2303
		Centrifugal	190	65	280	109	392	0.60	60	Standard	FAN2301
		Centrifugal	220	96	380	118	423	0.81	61	Standard	FAN2302

3 Speed

Classic Standard Profile	Duct (mm)	Fan Type	Scroll Dia. (mm)	Max. Fan Watts (W)	Max. Fan Pressure (Pa)	Free Air Fan Performance		Specific Fan Power (W/l/s)	Sound dB(A)	Switching	Product Code	
						(l/s)	(m ³ /hr)					
	150	Centrifugal	190	High	65	280	113	408	0.58	60	Standard	FAN2316
				Medium	57	250	94	340	0.61	56		
				Slow	55	200	77	277	0.71	46		
		Centrifugal	220	High	96	380	136	493	0.71	61	Standard	FAN2317
				Medium	69	340	113	408	0.61	56		
				Slow	60	280	94	340	0.64	50		





DESIGNED FOR G4 BUILDING CODE & HEALTHY HOMES – BATHROOMS



Extraction Fans - Centrifugal

CONTOUR fans deliver simple compliance with current New Zealand Building Code G4/AS1 mandatory mechanical extract ventilation system requirements. As well as providing application room specific performance, Contour **Toilet** and **Bathroom** fans have a comprehensive range of stylish, interchangeable fascia to choose from.

CONTOUR Bathroom Fan	Duct (mm)	Fan Type	Max. Fan Watts (W)	Max. Fan Pressure (Pa)	Free Air Fan Performance		Specific Fan Power (W/l/s)	Sound dB(A)	Fascia	Switching	Product Code
					(l/s)	(m ³ /hr)					
	150	Centrifugal	45	147	77	276	0.58	40	Range Selection (see below)	Standard	FAN7031
CONTOUR Toilet Fan	Duct (mm)	Fan Type	Max. Fan Watts (W)	Max. Fan Pressure (Pa)	Free Air Fan Performance		Specific Fan Power (W/l/s)	Sound dB(A)	Fascia	Switching	Product Code
					(l/s)	(m ³ /hr)					
	100	Centrifugal	30	93	49	175	0.61	38	Range Selection (see below)	Standard	FAN7030

Fascia Selections

Fan	Round				Square			
	White	Black	LED White	LED Black	White	Black	LED White	LED Black
								
Toilet	DCT4502	DCT4503	DCT4506	DCT4507	DCT4504	DCT4505	DCT4508	DCT4509
Bathroom	DCT4510	DCT4511	DCT4514	DCT4515	DCT4512	DCT4513	DCT4516	DCT4517

Inline Fans - Mixed Flow

The powerful MixFlo fans have been designed to produce higher working pressures for applications that require higher airflows with low relative noise levels. These large bore fans are designed for use with both rigid and flexible ducting. They offer two and half times the pressure of conventional axial fans and are dimensionally more compact making them ideal for many ducted applications. The impeller blade design with guide vanes provides optimum pressure characteristics. The fan can operate in both horizontal and vertical positions. Supported by a 4 year warranty or 30,000 continuous hours.

Pro-Series MIXFLO 2 Speed	Duct (mm)	Fan Type	Max. Fan Watts (W)	Max. Fan Pressure (Pa)	Free Air Fan Performance		Specific Fan Power (W/l/s)	Sound dB(A)	Switching	Product Code
					(l/s)	(m ³ /hr)				
	125	Mixed Flow	40	220	89	320	0.45	43	Standard	FAN1005
			26	160	72	260	0.36	36	Plug & Lead	FAN1051

Inline Extraction Fan Kits without Lights

This kit is designed so that the interior grille can be mounted directly above your steam source (eg: shower or bath). A low profile fascia is supplied with a choice of stylish grilles. Mixed flow fans provide users with a two fan speed option. 5 year warranty.

Pro-Series Low Profile	Duct (mm)	Fan Type	Max. Fan Watts (W)	Max. Fan Pressure (Pa)	Free Air Fan Performance		Specific Fan Power (W/l/s)	Fascia	Exterior Grille	Switching	Product Code
					(l/s)	(m ³ /hr)					
	125	Mixed Flow	40	220	89	320	0.45	Round White	Weatherproof Cowl White and Fixed Louvre White	Standard	FAN2050

DESIGNED FOR G4 BUILDING CODE & HEALTHY HOMES – BATHROOMS





Extraction Fans - THROUGH WALL MOUNTED ONLY



These axial fans are designed for easy installation and efficient operation. SELV (safety extra low voltage) fans are for use in wet area zones 1, 2 and 3 and incorporate a 12V AC motor and a 12V AC isolating transformer. Auto shutter models have automated backflow prevention vanes. 5 year warranty.

The new high-pressure and energy-efficient QUIET fans have ultra-high airflow without nuisance noise and are designed to be ducted straight through a bathroom or kitchen exterior wall. 5 year warranty.

Safety Extra Low Voltage (SELV)

Pro-Series Low Profile	Duct (mm)	Fan Type	Max. Fan Watts (W)	Max. Fan Pressure (Pa)	Free Air Fan Performance		Specific Fan Power (W/l/s)	Sound dB(A)	Fascia	Switching	Product Code
					(l/s)	(m ³ /hr)					
	125	Axial	20	35	36	130	0.56	41	Square	Standard	FAN5886
									Round	Standard	FAN5885
Classic Standard Profile	Duct (mm)	Fan Type	Max. Fan Watts (W)	Max. Fan Pressure (Pa)	Free Air Fan Performance		Specific Fan Power (W/l/s)	Sound dB(A)	Fascia	Switching	Product Code
					(l/s)	(m ³ /hr)					
	125	Axial	20	35	36	130	0.56	41	Square	Standard	FAN5890

Standard

Designer QUIET	Duct (mm)	Fan Type	Max. Fan Watts (W)	Max. Fan Pressure (Pa)	Free Air Fan Performance		Specific Fan Power (W/l/s)	Sound dB(A)	Fascia	Switching	Product Code
					(l/s)	(m ³ /hr)					
	125	Axial	15	68	54	194	0.28	38	Square	Standard	FAN7180
										Timer	FAN7181
										Humidity Control	FAN7182
Pro-Series Low Profile	Duct (mm)	Fan Type	Max. Fan Watts (W)	Max. Fan Pressure (Pa)	Free Air Fan Performance		Specific Fan Power (W/l/s)	Sound dB(A)	Fascia	Switching	Product Code
					(l/s)	(m ³ /hr)					
	125	Axial	20	35	36	130	0.56	41	Square	Standard	FAN0589
										Timer	FAN0590
									Round	Standard	FAN0604
										Timer	FAN0605
Classic Standard Profile	Duct (mm)	Fan Type	Max. Fan Watts (W)	Max. Fan Pressure (Pa)	Free Air Fan Performance		Specific Fan Power (W/l/s)	Sound dB(A)	Fascia	Switching	Product Code
					(l/s)	(m ³ /hr)					
	125	Axial	20	35	36	130	0.56	41	Square	Standard	FAN0072
										Pull Cord	FAN0074
										Timer	FAN0075



DESIGNED FOR G4 BUILDING CODE & HEALTHY HOMES – BATHROOMS





Through Wall Fan Kits



These axial fan kits are easy to install and are designed to be ducted straight through an exterior wall. SELV (safety extra low voltage) fans are for use in wet area zones 1, 2 and 3 and incorporate a 12V AC motor and a 12V AC isolating transformer. Auto shutter models have automated backflow prevention vanes. All kits include a weatherproof cowl. 5 year warranty.

The new high-pressure and energy-efficient QUIET fan kits have ultra-high airflow without nuisance noise and are designed to be ducted straight through a bathroom or kitchen exterior wall. All kits include a weatherproof cowl. 5 year warranty.

Safety Extra Low Voltage (SELV)

Pro-Series Low Profile	Duct (mm)	Fan Type	Max. Fan Watts (W)	Max. Fan Pressure (Pa)	Free Air Fan Performance		Specific Fan Power (W/l/s)	Sound dB(A)	Fascia	Switching	Product Code
					(l/s)	(m ³ /hr)					
	125	Axial	20	35	36	130	0.56	41	Square	Standard	FAN5887
									Round	Standard	FAN5888
Classic Standard Profile	Duct (mm)	Fan Type	Max. Fan Watts (W)	Max. Fan Pressure (Pa)	Free Air Fan Performance		Specific Fan Power (W/l/s)	Sound dB(A)	Fascia	Switching	Product Code
					(l/s)	(m ³ /hr)					
	125	Axial	20	35	36	130	0.56	41	Square	Standard	FAN5889

Standard

Designer QUIET	Duct (mm)	Fan Type	Max. Fan Watts (W)	Max. Fan Pressure (Pa)	Free Air Fan Performance		Specific Fan Power (W/l/s)	Sound dB(A)	Fascia	Switching	Product Code
					(l/s)	(m ³ /hr)					
	125	Axial	15	68	54	194	0.28	38	Square	Standard	FAN7187
										Timer	FAN7188
										Humidity Control	FAN7189
Pro-Series Low Profile	Duct (mm)	Fan Type	Max. Fan Watts (W)	Max. Fan Pressure (Pa)	Free Air Fan Performance		Specific Fan Power (W/l/s)	Sound dB(A)	Fascia	Switching	Product Code
					(l/s)	(m ³ /hr)					
	125	Axial	20	35	36	130	0.56	41	Square	Standard	FAN0614
										Timer	FAN0615
Classic Standard Profile	Duct (mm)	Fan Type	Max. Fan Watts (W)	Max. Fan Pressure (Pa)	Free Air Fan Performance		Specific Fan Power (W/l/s)	Sound dB(A)	Fascia	Switching	Product Code
					(l/s)	(m ³ /hr)					
	125	Axial	20	35	36	130	0.56	41	Square	Standard	FAN0080
										Pull Cord	FAN0082
										Timer	FAN0083

DESIGNED FOR G4 BUILDING CODE & HEALTHY HOMES – BATHROOMS





Through Wall Fan Kits - Intelligent Sensing Automation

FOR CONTINUOUS OPERATION COMPLIANCE ONLY

IntelliVent fans are sensor operated complete with adjustable speed control and LED function indication. Easy access to the control panel provides for simple and exact adjustment of settings. Includes energy efficient DC motor. 5 year warranty.



The GENIUS is the new generation of unitary fans. Following installation home owners automatically have a ventilation system offering a wide range of standard default operating settings which can be easily customised via an intuitive App. Includes energy efficient DC motor.

Designer INTELLIVENT	Duct (mm)	Fan Type	Max. Fan Watts (W)	Max. Fan Pressure (Pa)	Free Air Fan Performance		Specific Fan Power (W/l/s)	Sound dB(A)	Fascia	Switching	Product Code
					(l/s)	(m ³ /hr)					
	125	DC Axial	8	21	37	134	0.22	21	Rectangle	Auto Sense Humidity	FAN5901

Designer GENIUS	Duct (mm)	Fan Type	Max. Fan Watts (W)	Max. Fan Pressure (Pa)	Free Air Fan Performance		Specific Fan Power (W/l/s)	Sound dB(A)	Fascia	Switching	Product Code
					(l/s)	(m ³ /hr)					
	100	DC Axial	4	30	30	108	0.13	17-20	Round	App Control	FAN6844

Heat-Fan-Light Systems

These multi-function systems are designed to meet the higher operational demands of both small and large bathrooms. Fans incorporate a unique anti-condensate design and efficient heating system. All systems are supplied with duct, grille and wall switch.

Designer Low Profile	Duct (mm)	Fan Type	Total Watts (W)	Max. Fan Pressure (Pa)	Free Air Fan Performance		Heating	Fascia	Order Code
					(l/s)	(m ³ /hr)			
	150	2 x Centrifugal	2115	145	106	380	2 Level PTC 1100W/2000W	White	FAN7020
								Black	FAN7021
	150	Centrifugal	1080	146	99	356	1 x 1000W Halogen	White	FAN5876
Pro-Series Vivo	Duct (mm)	Fan Type	Total Watts (W)	Max. Fan Pressure (Pa)	Free Air Fan Performance		Heating	Fascia	Order Code
					(l/s)	(m ³ /hr)			
	125	Centrifugal	2100	115	92	330	2 Level PTC 1400W/2000W	White	FAN7291



DESIGNED FOR HEALTHY HOMES STANDARD - BATHROOMS & KITCHENS



Inline Fans - Centrifugal

Centrifugal fans create high pressure airflows and are best suited for high pressure applications such as drying and air conditioning systems. 2 year warranty.

Classic High Performance	Duct (mm)	Fan Type	Max. Fan Watts (W)	Max. Fan Pressure (Pa)	Free Air Fan Performance		Specific Fan Power (W/l/s)	Sound dB(A)	Switching	Product Code
					(l/s)	(m ³ /hr)				
	150	Centrifugal	57	320	124	445	0.46	50	Standard	FAN0330

DESIGNED FOR HEALTHY HOMES STANDARD - BATHROOMS



Inline Fans - Mixed Flow

The powerful MixFlo fans have been designed to produce higher working pressures for applications that require higher airflows with low relative noise levels.

These large bore fans are designed for use with both rigid and flexible ducting. They offer two and half times the pressure of conventional axial fans and are dimensionally more compact making them ideal for many ducted applications. The impeller blade design with guide vanes provides optimum pressure characteristics. The fan can operate in both horizontal and vertical positions. Supported by a 4 year warranty or 30,000 continuous hours.

Pro-Series MIXFLO 2 Speed	Duct (mm)	Fan Type	Max. Fan Watts (W)	Max. Fan Pressure (Pa)	Free Air Fan Performance		Specific Fan Power (W/l/s)	Sound dB(A)	Switching	Product Code
					(l/s)	(m ³ /hr)				
	100	Mixed Flow	40	180	69	250	0.58	40	Standard	FAN1004
26			120	53	190	0.49	Plug & Lead		FAN1050	

Inline Fans - Centrifugal

Centrifugal fans create high pressure airflows and are best suited for high pressure applications such as drying and air conditioning systems. Suitable for a variety of domestic applications, these inline centrifugal 3 speed fans provide high performance at your pre-set choice of speed and can also be used for supply. 2 year warranty.

Classic High Performance	Duct (mm)	Fan Type	Max. Fan Watts (W)	Max. Fan Pressure (Pa)	Free Air Fan Performance		Specific Fan Power (W/l/s)	Sound dB(A)	Switching	Product Code
					(l/s)	(m ³ /hr)				
	100	Centrifugal	32	153	49	176	0.65	38	Standard	FAN0361



DESIGNED FOR HEALTHY HOMES STANDARD - BATHROOMS



Inline Extraction Fan Kits without Lights

These kits are designed so that the interior grille can be mounted directly above your steam source (eg: shower or bath). Kits with the low profile fascia are supplied with a choice of stylish grilles. Mixed flow fans provide users with a two fan speed option. 5 year warranty.

Pro-Series Low Profile	Duct (mm)	Fan Type	Max. Fan Watts (W)	Max. Fan Pressure (Pa)	Free Air Fan Performance		Specific Fan Power (W/l/s)	Fascia	Exterior Grille	Switching	Product Code
					(l/s)	(m ³ /hr)					
	100	Mixed Flow	40	180	69	250	0.58	Round White	Weatherproof Cowl White and Fixed Louvre White	Standard	FAN2049
	125	Centrifugal	20	120	39	140	0.51	Square White	and Fixed Louvre White	Timer	FAN0617
Classic Standard Profile	Duct (mm)	Fan Type	Max. Fan Watts (W)	Max. Fan Pressure (Pa)	Free Air Fan Performance		Specific Fan Power (W/l/s)	Fascia	Exterior Grille	Switching	Product Code
					(l/s)	(m ³ /hr)					
	125	Axial	20	35	36	130	0.56	Round White	Fixed Louvre White	Standard	FAN0064
	125	Axial	20	35	36	130	0.56	Round White	Fixed Louvre White	Timer	FAN0065
	100	Centrifugal	20	120	31	110	0.65	Round White	Fixed Louvre White	Standard	FAN0328

Inline Extraction Fan Kits with LED Lights

These high efficiency inline fans are designed to provide higher levels of extraction for larger bathrooms and the LED light adds light directly above your steam source (eg: shower or bath). 5 year warranty.

Classic Standard Profile	Duct (mm)	Fan Type	Max. Fan Watts (W)	Max. Fan Pressure (Pa)	Free Air Fan Performance		Specific Fan Power (W/l/s)	Fascia	Exterior Grille	Switching	Product Code
					(l/s)	(m ³ /hr)					
	125	Axial	20	35	36	130	0.56	Round White	Eggcrate White	Standard	FAN5371
	125	Axial	20	35	36	130	0.56	Round White	Eggcrate White	Timer	FAN5372

Inline Extraction Fan Kits with Halogen Lights

These high efficiency inline fans are designed to provide higher levels of extraction for larger bathrooms and the halogen light adds light directly above your steam source (eg: shower or bath). 5 year warranty.

Classic Standard Profile	Duct (mm)	Fan Type	Max. Fan Watts (W)	Max. Fan Pressure (Pa)	Free Air Fan Performance		Specific Fan Power (W/l/s)	Fascia	Exterior Grille	Switching	Product Code
					(l/s)	(m ³ /hr)					
	125	Axial	20	35	36	130	0.56	Round White	Eggcrate White	Standard	FAN2037
	125	Axial	20	35	36	130	0.56	Round White	Eggcrate White	Timer	FAN2038

DESIGNED FOR HEALTHY HOMES STANDARD - BATHROOMS



Heater-Fan-Light Systems

This multi-function system is designed to meet the higher operational demands of both small and large bathrooms. Fans incorporate a unique anti-condensate design and efficient heating system. System is supplied with duct, grille and wall switch.

Designer Low Profile	Duct (mm)	Fan Type	Total Watts (W)	Max. Fan Pressure (Pa)	Free Air Fan Performance		Heating	Fascia	Order Code
					(l/s)	(m ³ /hr)			
	150	Centrifugal	1100	146	69	248	1 x 1000W Halogen	White	FAN6577

Heat-Fan-Light Systems

These multi-function systems are designed to meet the higher operational demands of both small and large bathrooms. Fans incorporate a unique anti-condensate design and efficient heating system. All systems are supplied with duct, grille and wall switch.

Designer SATIN Low Profile	Duct	Fan Type	Total Watts (W)	Max. Fan Pressure (Pa)	Free Air Fan Performance		Heat Lamps	Fascia	Product Code
					(l/s)	(m ³ /hr)			
	125	Centrifugal	1138	TBC	84	303	4 x 275W	White	FAN6882
	125	Centrifugal	1138	TBC	84	303	4 x 275W	Silver	FAN6883
	125	Centrifugal	588	71	75	270	2 x 275W	White	FAN6880
	125	Centrifugal	588	71	75	270	2 x 275W	Silver	FAN6881
Pro-Series Low Profile	Duct	Fan Type	Total Watts (W)	Max. Fan Pressure (Pa)	Free Air Fan Performance		Heat Lamps	Fascia	Product Code
					(l/s)	(m ³ /hr)			
	125	Centrifugal	1180	83	60	216	4 x 275W	White	FAN0995
	125	Centrifugal	635	79	50	180	2 x 275W	White	FAN0940





HOME VENTILATION SYSTEMS

For High Background Noise Compliance Get it Right Onsite

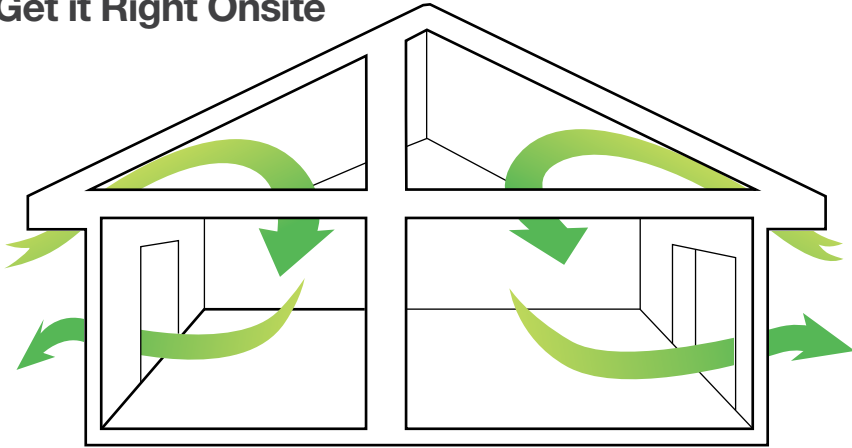

If you need assistance with building consents for high background noise affected sites, we can expedite the process by providing you with the ventilation system reports you need. We can even work directly with the electrical contractor you already have onsite to complete the installation*.

* Other options are available if this is not suitable

- 👍 Building code compliance
- 👍 Positive pressure and heat & energy recovery solutions
- 👍 System upgrade options
- 👍 5 year warranty

Free planning service
0800 140 150



enquiry@smartvent.co.nz | www.smartvent.co.nz



Scan to upload
your building plans

MANROSE
DESIGNER SERIES

CONTOUR
FAN SYSTEMS

Setting the **Standards**
in **Ventilation Solutions**



Manrose Contour Fan Systems

the new standard in powerful, stylish, easy to install, configurable extract systems









Ceiling Extraction Fans – Centrifugal

Manrose CONTOUR fans deliver simple compliance with current New Zealand Building Code G4/AS1 mandatory mechanical extract ventilation system requirements. As well as providing application room specific performance, Contour **Toilet**, **Bathroom** and **Kitchen & Laundry** fans have a comprehensive range of stylish, interchangeable fascia to choose from.

CONTOUR Toilet Fan	Duct (mm)	Fan Type	Max. Fan Watts (W)	Max. Fan Pressure (Pa)	Free Air Fan Performance		Specific Fan Power (W/l/s)	Sound dB(A)	Fascia	Switching	Order Code
					(l/s)	(m³/hr)					
	100	Centrifugal	30	93	49	175	0.61	38	Range Selection	Standard	FAN7030
	150	Centrifugal	45	147	77	276	0.58	40	Range Selection	Standard	FAN7031
	150	Centrifugal	50	210	105	378	0.48	42	Range Selection	Standard	FAN7032
	150	Centrifugal	106	220	153	550	0.69	42	Round White	Standard	FAN7033
	150	Centrifugal	106	220	153	550	0.69	42	Square White	Standard	FAN7034

- Fitted lead and plug
- Integrated backdraught shutter
- Deep spigot for easy duct connection
- Swing-out arms for easy installation

Fascia Selections

Fan	Round				Square			
	White	Black	LED White	LED Black	White	Black	LED White	LED Black
								
Toilet	DCT4502	DCT4503	DCT4506	DCT4507	DCT4504	DCT4505	DCT4508	DCT4509
Bathroom	DCT4510	DCT4511	DCT4514	DCT4515	DCT4512	DCT4513	DCT4516	DCT4517
Kitchen and Laundry								

Ceiling Extraction Fans – Centrifugal

Dimensions (mm)

Model	A	B (cut-out size)	C (fascia size)	D
Toilet	170	240	272	100
Bathroom	197	296	328	150
Kitchen and Laundry	197	296	328	150
High Steam Area	197	296	326	150

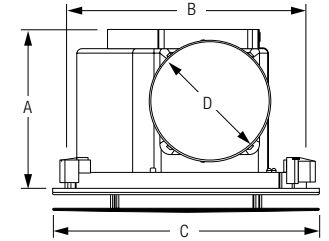

Technical

Model	Toilet	Bathroom	Kitchen and Laundry	High Steam Area
Supply	220-240V AC, 50Hz			
Max. Operating Temp	40°C	40°C	40°C	40°C
	(W)	10	14	14
	(lm)	850	1265	1265
	(K)	4200	4200	4200
	(W)	10	14	14
	(lm)	850	1290	1290
	(K)	4200	4200	4200
IP Rating	IP44			

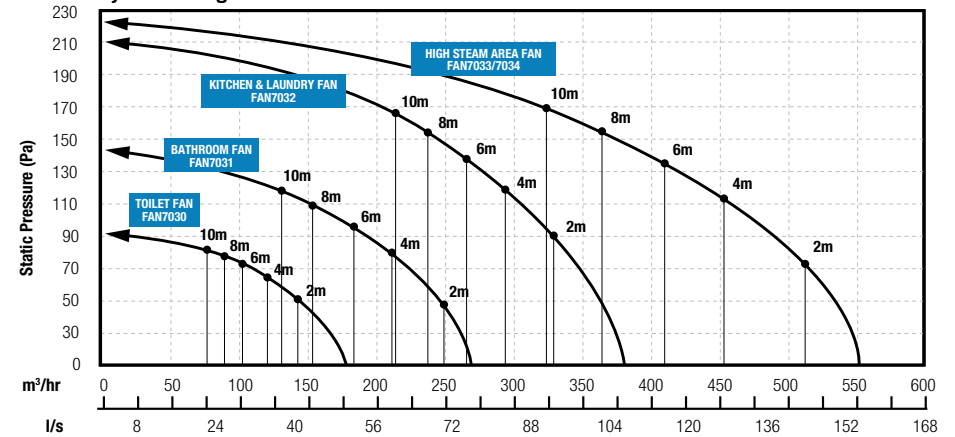

Airflow by Duct Length



Inline Fans - Mixed Flow

Blue Jet incorporates powerful jet streaming technology and is driven by the energy efficient, brushless EC motor to deliver best-in-class airflow performance. A surface mounted variable speed control, and 10m control cable, is supplied along with a plug and lead for the fan. The Blue Jet fan is suitable for all residential applications. 5 year warranty.

The powerful inline MixFlo fans have been designed to produce higher working pressures for applications that require higher airflows with low relative noise levels. These large bore fans are designed for use with both rigid and flexible ducting. They offer two and half times the pressure of conventional axial fans and are dimensionally more compact making them ideal for many ducted applications. The impeller blade design with guide vanes provides optimum pressure characteristics. The fan can operate in both horizontal and vertical positions. Supported by a 4 year warranty or 30,000 continuous hours.

Designer BLUE JET	Duct (mm)	Fan Type	Max. Fan Watts (W)	Max. Fan Pressure (PA)	Free Air Fan Performance		Specific Fan Power (W/l/s)	Sound dB(A)	Switching	Order Code	
					(l/s)	(m ³ /hr)					
	150	EC Mixed Flow	40	490	165	594	0.24	60	Variable Speed Controller	FAN6960	
Pro-Series MIXFLO 3 Speed	Duct (mm)	Fan Type	Max. Fan Watts (W)	Max. Fan Pressure (PA)	Free Air Fan Performance		Specific Fan Power (W/l/s)	Sound dB(A)	Switching	Model	Order Code
					(l/s)	(m ³ /hr)					
	200	Mixed Flow	85	250	272	980	0.31	48	Standard	MF200S	FAN1007
			60	140	239	860	0.25	45	Plug & Lead	MF200PL	FAN1053
			45	80	196	706	0.23	41			
Pro-Series MIXFLO 2 Speed	Duct (mm)	Fan Type	Max. Fan Watts (W)	Max. Fan Pressure (PA)	Free Air Fan Performance		Specific Fan Power (W/l/s)	Sound dB(A)	Switching	Model	Order Code
					(l/s)	(m ³ /hr)					
	150	Mixed Flow	70	300	166	597	0.42	47	Standard	MF150S	FAN1006
			60	240	92	330	0.65	40	Plug & Lead	MF150PL	FAN1048
			40	220	89	320	0.45	43	Standard	MF125S	FAN1005
	125	Mixed Flow	26	160	72	260	0.36	36	Plug & Lead	MF125PL	FAN1051
			40	180	69	250	0.58	40	Standard	MF100S	FAN1004
	100	Mixed Flow	26	120	53	190	0.49	33	Plug & Lead	MF100PL	FAN1050

Note: Installed system performance is always influenced by duct length and layout

Switching Options

Standard Remote switch (not supplied).

Timer Remote switch (not supplied). Fan continues operating for preset time after switching off.

Inline Fans - Mixed Flow

Dimensions (mm)

Model	A	B	C	D	E	F	G	H	J	K
Blue Jet	125	15	150	154	24	176	51	37	175	184
MF200	244	197	354	50	230	142	140		-	
MF150	209	147	360	55	195	130	115		-	
MF125	182	122	350	60	168	100	100		-	
MF100	182	98	315	27	168	100	100		-	

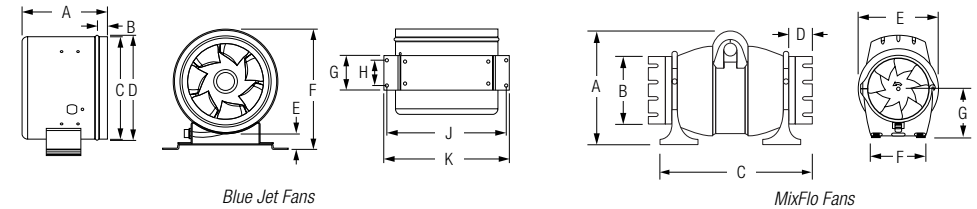

Technical

Model	Blue Jet		Mixflo		
	150mm	200mm	150mm	125mm	100mm
Supply	220-240V AC, 50Hz				
Max. Operating Temp	40°C	60°C	60°C	45°C	45°C
IP Rating	IPX4	IPX4	IPX4	IPX4	IPX4

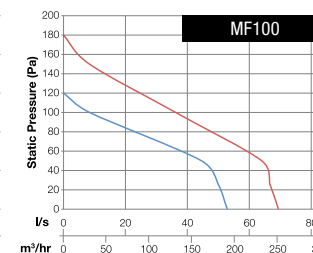
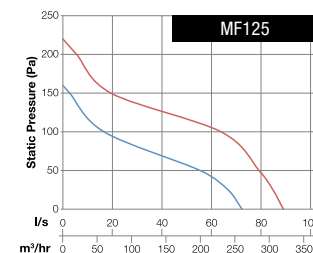
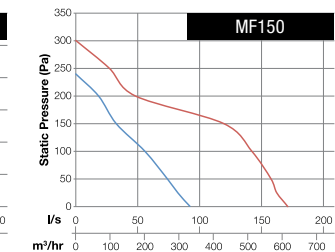
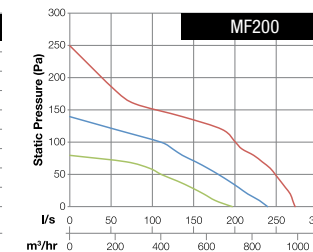
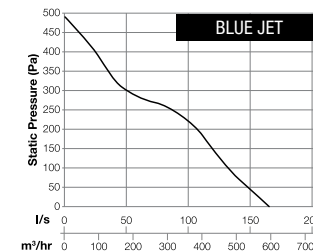

Sound Levels - dB(A)



Model	Duct	125	250	500	1K	2K	4K	8K
MF	200	18	33	43	53	49	41	30
	150	15	39	51	53	53	47	38
	125	10	34	42	49	36	35	24
	100	10	34	42	49	36	35	24





Inline Fans - Axial

The Hyper150 EC axial fan is the trusted leader in bathroom extraction. Now with an EC motor, other ongoing improvements and variable speed control with 10m control cable, Hyper150 continues to lead the field. 7 year warranty.

Ceiling mounted ID and ECO fans have a range of performance levels for short and efficient duct systems. 2 year warranty.

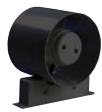
Classic HYPER150 EC	Duct (mm)	Fan Type	Max. Fan Watts (W)	Max. Fan Pressure (Pa)	Free Air Fan Performance		Specific Fan Power (W/l/s)	Sound dB(A)	Switching	Order Code
					(l/s)	(m ³ /hr)				
	150	EC Axial	18	91	105	380	0.17	38	Standard	FAN0085
	150	EC Axial	18	91	105	380	0.17	38	Variable Speed Controller**	FAN7000*

Classic	Duct (mm)	Fan Type	Max. Fan Watts (W)	Max. Fan Pressure (Pa)	Free Air Fan Performance		Specific Fan Power (W/l/s)	Sound dB(A)	Switching	Model	Order Code
					(l/s)	(m ³ /hr)					
	150	Axial	25	60	87	313	0.29	40	Standard	ID150S	FAN0090
									Timer	ID150T	FAN0091
	125	Axial	20	35	36	130	0.56	41	Standard	ID125S	FAN0060
									Timer	ID125T	FAN0061
100	Axial	20	25	23	85	0.87	41	Standard	ID100S	FAN0012	
								Timer	ID100T	FAN0013	

Classic ECONOMY	Duct (mm)	Fan Type	Max. Fan Watts (W)	Max. Fan Pressure (Pa)	Free Air Fan Performance		Specific Fan Power (W/l/s)	Sound dB(A)	Switching	Model	Order Code
					(l/s)	(m ³ /hr)					
	150	Axial	25	50	64	230	0.39	40	Standard	ECO150S	FAN2078

*All data for FAN7000 at full speed

**Euro flush-box for variable speed control switch – included

Note: Installed system performance is always influenced by duct length and layout

Switching Options

Standard Remote switch (not supplied).

Timer Remote switch (not supplied). Fan continues operating for preset time after switching off.

Inline Fans - Axial

Dimensions (mm)

Model	A	B	C	D	E
Hyper150 EC	200	143	170	185	-
ID150	187	153	109	150	27
ID125	150	155	99	118	27
ID100	130	155	90	100	27
ECO150	187	153	109	150	27

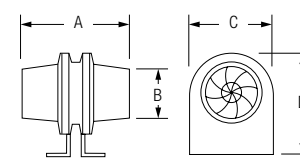

Hyper150 EC Fans

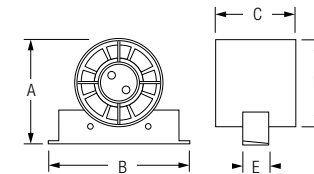

ID & ECO Fans

Technical

Model	Hyper150 EC	ID150	ID125	ID100	ECO150
Supply	110-240V AC, 50Hz	220-240V AC, 50Hz			
Sound Level	38 dB(A)	40 dB(A)	41 dB(A)	41 dB(A)	40 dB(A)
Max. Operating Temp	45°C	40°C	40°C	40°C	50°C
IP Rating	IP44	IP44	IP44	IP44	IPX4



Inline Fans - Centrifugal 3 Speed

Suitable for a variety of domestic applications, these inline centrifugal fans provide high performance at your preset choice of speed. Can also be used for supply. 2 year warranty.

Classic 3 Speed	Duct (mm)	Fan Type & Speed	Max. Fan Watts (W)	Max. Fan Pressure (Pa)	Free Air Fan Performance		Specific Fan Power (W/l/s)	Sound dB(A)	Switching	Model	Order Code
					(l/s)	(m ³ /hr)					
	200	Centrifugal Speed 1 Speed 2 Speed 3	(tba)	200	130	466	(tba)	(tba) (tba) 56	Standard	MAN200-3	FAN0997
			(tba)	275	161	580	(tba)				
			105	310	180	648	0.58				
	150	Centrifugal Speed 1 Speed 2 Speed 3	41	225	86	310	0.48	30 36 43	Standard	MAN150-3	FAN0921
			46	296	122	440	0.38				
			57	356	149	535	0.34				

Note: Installed system performance is always influenced by duct length and layout

See page 90 for more information on centrifugal fan mounting brackets FAN0015 and FAN0016.

Switching Options

Standard Remote switch (not supplied).

Inline Fans - Centrifugal 3 Speed

Dimensions (mm)

Model	ØA	ØB	C	D	E	F
MAN200	340	200	279	154	50	75
MAN150	340	150	279	154	50	75

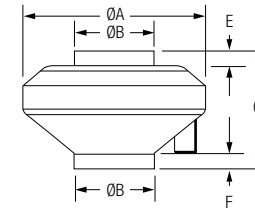

MAN200 / MAN150

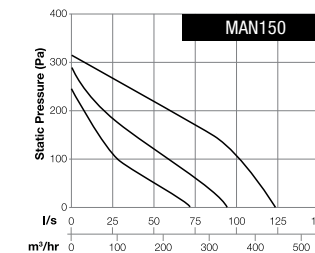
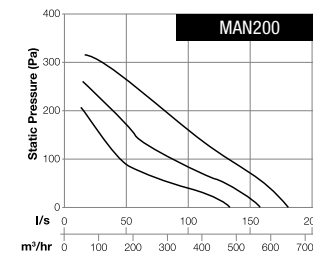

Technical

Model	MAN200	MAN150
Supply	220-240V AC, 50Hz	
Max. Operating Temp	50°C	
IP Rating	IPX4	



Inline Fans - Centrifugal

The following high performance centrifugal inline fans are suitable for a variety of domestic applications and can also be used for supply. 2 year warranty.

Classic High Performance	Duct (mm)	Fan Type	Max. Fan Watts (W)	Max. Fan Pressure (Pa)	Free Air Fan Performance		Specific Fan Power (W/l/s)	Sound dB(A)	Switching	Model	Order Code
					(l/s)	(m ³ /hr)					
	315	Centrifugal	318	720	472	1700	0.67	52	Standard	MAN315L	FAN0356
			176	590	360	1300	0.49	48	Standard	MAN315	FAN0357
	250	Centrifugal	170	500	280	1010	0.61	47	Standard	MAN250	FAN0358
	200	Centrifugal	105	418	208	750	0.50	56	Standard	MAN200	FAN0467
	150	Centrifugal	57	320	124	445	0.46	50	Standard	MAN150	FAN0330
100	Centrifugal	32	153	49	176	0.65	38	Standard	MAN100	FAN0361	
WhisperVent	Duct (mm)	Fan Type	Max. Fan Watts (W)	Max. Fan Pressure (Pa)	Free Air Fan Performance		Specific Fan Power (W/l/s)	Sound dB(A)	Switching	Model	Order Code
	150	Centrifugal	80	305	124	445	0.65	43	Standard	WVILP150-1	FAN0829
Classic	Duct (mm)	Fan Type	Max. Fan Watts (W)	Max. Fan Pressure (Pa)	Free Air Fan Performance		Specific Fan Power (W/l/s)	Sound dB(A)	Switching	Model	Order Code
	100	Centrifugal	20	120	31	110	0.65	45	Standard	CFD200S	FAN0326
									Timer	CFD200T	FAN0327

Note: Installed system performance is always influenced by duct length and layout

See page 90 for more information on centrifugal fan mounting brackets FAN0015 and FAN0016.

Switching Options

Standard Remote switch (not supplied).

Timer Remote switch (not supplied). Fan continues operating for preset time after switching off. 1-20 minute adjustable.

Inline Fans - Centrifugal

Dimensions (mm)

Model	ØA	ØB	C	D	E	F
MAN315	405	315	275	215	30	30
MAN250	320	249	440	310	65	65
MAN200	340	200	279	154	50	75
MAN150	340	150	279	154	50	75
MAN100	250	100	256	136	50	70
WVILP150	313	168	148	340	218	-
CFD200	100	155	100	195	258	-

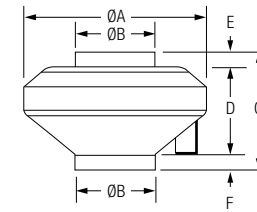
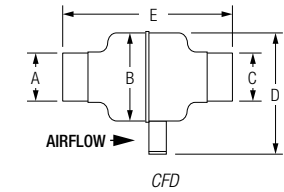

MAN

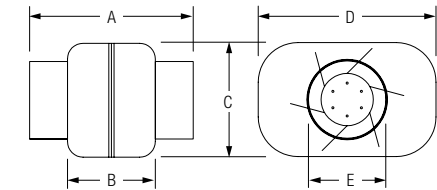

WVILP150-1

Technical

Model	MAN315L	MAN315	MAN250	MAN200	MAN150	MAN100	WVILP	CFD
Supply	220-240V AC, 50Hz							
Max. Operating Temp	40°C	60°C	50°C	60°C	50°C	60°C	40°C	40°C
IP Rating	IPX4	IPX4	IPX4	IPX4	IPX4	IPX4	IPX4	IP44

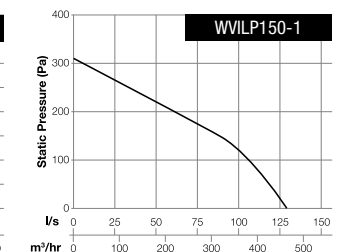
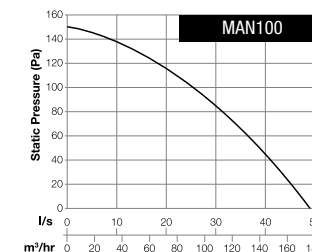
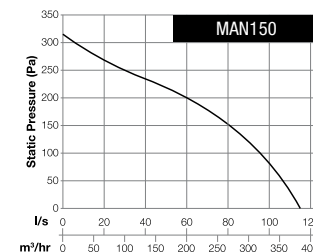
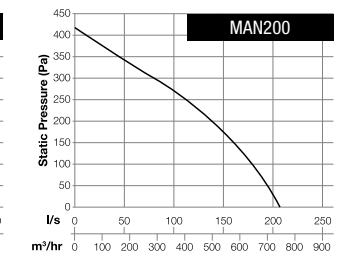
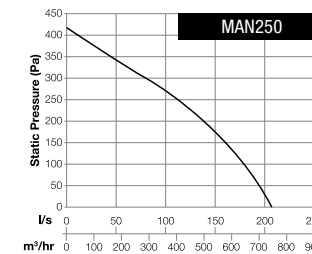
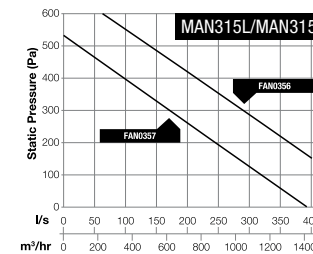

Inline Extraction Kits - Ready for Contour Fascia Selection

These kits are designed so that the interior grille can be mounted directly above your steam source (e.g. shower or bath). The adapter unit has a comprehensive range of stylish, interchangeable fascia to choose from.

A 150mm duct connecting ceiling plenum, with 90° ovalised moulded plastic elbow outlet and back-flow preventer for unimpeded airflow, is also available as a separate alternative option to the adapter unit. 5 year warranty.

Designer Standard Profile	Duct (mm)	Fan Type	Max. Fan Watts (W)	Max. Fan Pressure (Pa)	Free Air Fan Performance		Specific Fan Power (W/l/s)	Fascia	Exterior Grille	Switching	Order Code
					(l/s)	(m³/hr)					
	150	Mixed Flow	70 60	300 240	166 92	597 330	0.42 0.65	Range Selection	White Fixed Louvre	Standard	FAN7366
	150	EC Axial	18	91	105	380	0.17	Range Selection	White Fixed Louvre	Standard	FAN7044

Note: Installed system performance is always influenced by duct length and layout

Switching Options

Standard Remote switch (not supplied).

Fascia Selections

Adapter Plate <i>supplied with kits above</i>	Round				Square			
	White	Black	LED White	LED Black	White	Black	LED White	LED Black
								
DCT4500	DCT4502	DCT4503	DCT4506	DCT4507	DCT4504	DCT4505	DCT4508	DCT4509

Ceiling Plenum <i>(order separately)</i>	Round				Square			
	White	Black	LED White	LED Black	White	Black	LED White	LED Black
								
DCT4501	DCT4502	DCT4503	DCT4506	DCT4507	DCT4504	DCT4505	DCT4508	DCT4509

- Fascias are a stylish super low profile slim line design available in white or black
- 10W LED light panel fascia options include driver with quick connection 12V plug and pre-fitted 240V AC supply lead and plug
- Fascias are easy to install, remove and clean

Inline Extraction Kits - Ready for Contour Fascia Selection

Dimensions (mm)

Model	A	B	C	D	E	F	G
FAN7366	209	147	360	55	195	130	115
FAN7044	200	143	170	185	-	-	-
Adapter Plate	75	265	-	-	-	-	-
Ceiling Plenum	196-167 (adjustable)	265	190	103	-	-	-
Round Fascia	272	-	-	-	-	-	-
Square Fascia	272	272	-	-	-	-	-

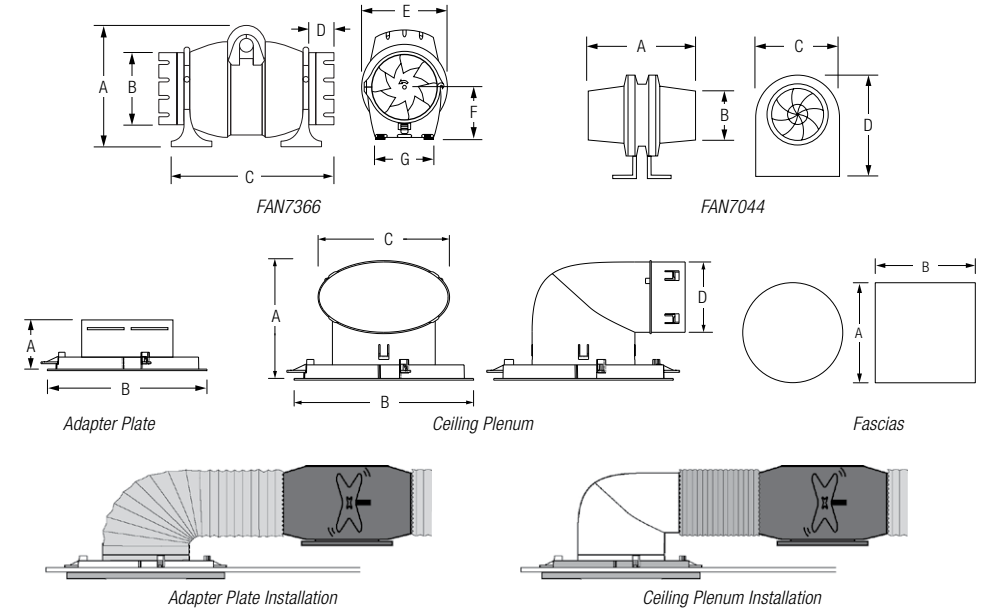

Technical

Model	FAN7366	FAN7044	LED Fascia
Supply		220-240V AC, 50Hz	
Sound Level	40/47dB(A)	38 dB(A)	-
Max. Operating Temp		45°C	-
Wattage	60-70W	18W	10W
Light			850 lm
LED Colour			42000K
IP Rating		IP44	

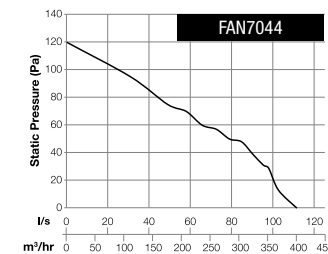
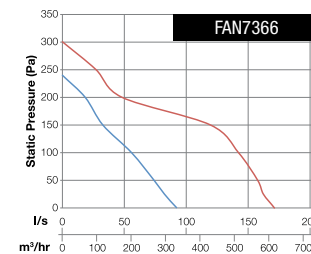

Inline Extraction Fan Kits without Lights

These kits are designed so that the interior grille can be mounted directly above your steam source (e.g. shower or bath). Kits with the low profile fascia are supplied with a choice of stylish grilles. Mixed flow fans provide users with a two fan speed option. 5 year warranty.

Pro-Series Low Profile	Duct (mm)	Fan Type	Max. Fan Watts (W)	Max. Fan Pressure (PA)	Free Air Fan Performance		Specific Fan Power (W/l/s)	Interior Grille	Exterior Grille	Switching	Model	Order Code
					(l/s)	(m³/hr)						
	150	Mixed Flow	70 60	300 240	166 92	597 330	0.42 0.65	Round White	Weatherproof Cowl White and Fixed Louvre White	Standard	MFLP150S	FAN2051
	125	Mixed Flow	40 26	220 160	89 72	320 260	0.45 0.36	Round White	Weatherproof Cowl White and Fixed Louvre White	Standard	MFLP125S	FAN2050
	100	Mixed Flow	40 26	180 120	69 53	250 190	0.58 0.49	Round White	Weatherproof Cowl White and Fixed Louvre White	Standard	MFLP100S	FAN2049
	150	EC Axial	18	91	105	380	0.17	Round White and Square White	Weatherproof Cowl White and Fixed Louvre White	Standard	SFLP150S	FAN0618
										Timer	SFLP150T	FAN0619
	125	Centrifugal	20	120	39	140	0.51	Round White and Square White	Weatherproof Cowl White and Fixed Louvre White	Timer	SFLP125T	FAN0617
Classic Standard Profile	Duct (mm)	Fan Type	Max. Fan Watts (W)	Max. Fan Pressure (Pa)	Free Air Fan Performance		Specific Fan Power (W/l/s)	Interior Grille	Exterior Grille	Switching	Model	Order Code
					(l/s)	(m³/hr)						
	150	EC Axial	18	91	105	380	0.17	Round Black & White	Fixed Louvre White	Variable Speed Controller	SF150S	FAN7500
	150	EC Axial	18	91	105	380	0.17	Round Black & White	Fixed Louvre White	Standard	SF150S	FAN0101
Round White									Timer	SF150T	FAN0102	
	125	Axial	20	35	36	130	0.56	Round White	Fixed Louvre White	Standard	SF125S	FAN0064
										Timer	SF125T	FAN0065
	100	Centrifugal	20	120	31	110	0.65	Round White	Fixed Louvre White	Standard	SF200S	FAN0328
		Axial	20	24	23	85	0.87	Round White	Fixed Louvre White	Standard	SF100S	FAN0017
										Timer	SF100T	FAN0018

Note: Installed system performance is always influenced by duct length and layout

Switching Options

- Standard** Remote switch (not supplied).
- Timer** Remote switch (not supplied). Fan continues operating for preset time after switching off.

Inline Extraction Fan Kits without Lights

Dimensions (mm)

Model	Grille Cut-Out	A	B	C	D	E	F	G
MFLP150	160	209	147	360	55	195	115	130
MFLP125	140	182	122	350	60	168	100	100
MFLP100	115	182	98	315	27	168	100	100
SFLP150	160	200	143	170	185	-	-	-
SFLP125	140	182	122	350	60	168	100	100
SF150	160	200	143	170	185	-	-	-
SF125	140	155	150	99	118	27	-	-
SF200	115	100	155	100	195	258	-	-
SF100	115	155	130	90	100	27	-	-

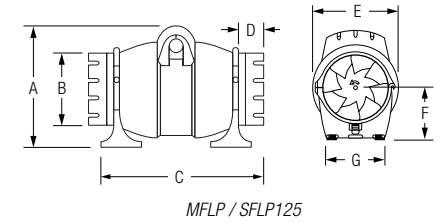

Note: Grille cut-out size is a nominal diameter for a circular cut-out.

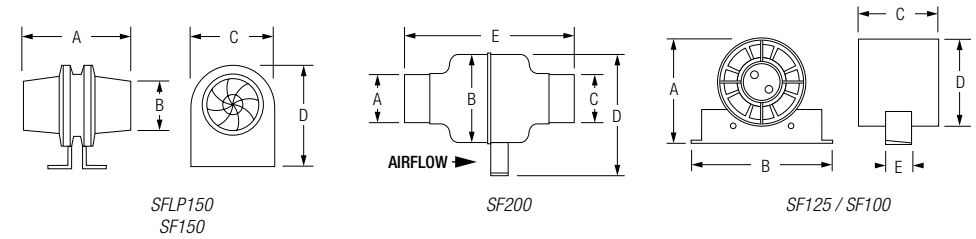

Technical

Model	MFLP150	MFLP125	MFLP100	SFLP150	SFLP125	SF150	SF125	SF200	SF100
Supply	220-240V AC, 50Hz								
Sound Level	47 dB(A)	43 dB(A)	40 dB(A)	38 dB(A)	43 dB(A)	38 dB(A)	41 dB(A)	45 dB(A)	41 dB(A)
Max. Operating Temp	60°C	45°C	45°C	45°C	45°C	45°C	50°C	50°C	50°C
IP Rating	IPX4	IPX4	IPX4	IP44	IPX4	IP44	IPX4	IPX4	IPX4
Duct	6m Unilok Nude		5m Flexible PVC		4m Flexible PVC		5m Flexible PVC		3m Flexible PVC

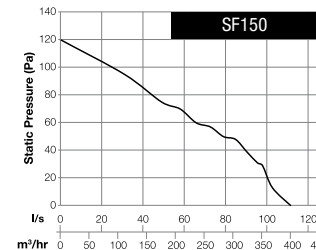
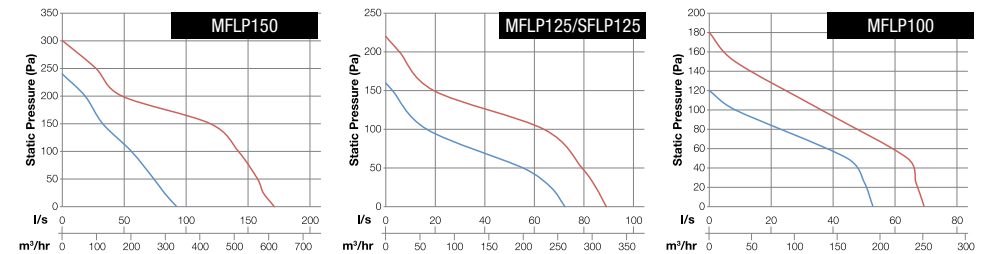

Inline Extraction Fan Kits with LED

These high efficiency inline fans are designed to provide higher levels of extraction for larger bathrooms and the LED adds light directly above your steam source (e.g. shower or bath). Mixed flow fans provide users with a two fan speed option. 5 year warranty.

Classic Standard Profile	Duct (mm)	Fan Type	Max. Fan Watts (W)	Max. Fan Pressure (Pa)	Free Air Fan Performance		Specific Fan Power (W/l/s)	Interior Grille	Exterior Grille	Switching	Model	Order Code
					(l/s)	(m ³ /hr)						
	150	EC Axial	18	91	105	380	0.17	Round White	Eggcrate White	Standard	EL150S	FAN5369
										Timer	EL150T	FAN5370
	125	Axial	20	35	36	130	0.56	Round White	Eggcrate White	Standard	EL125S	FAN5371
										Timer	EL125T	FAN5372
	100	Centrifugal	20	120	31	110	0.65	Round White	Eggcrate White	Standard	EL100S	FAN5373
										Timer	EL100T	FAN5374

Note: Installed system performance is always influenced by duct length and layout

Switching Options

Standard Remote switch (not supplied).

Timer Remote switch (not supplied). Fan continues operating for preset time after switching off. 150mm models include fixed 7 minute timer. 125mm and 100mm model timers are 1-20 minute adjustable and require permanent and switched phase.

Accessories

Diffuser with LED (12V 3W) and Driver	Model	White	Chrome
	EL150	DCT3209	DCT3208
	EL125	DCT3207	-
	EL100	DCT3205	-

Inline Extraction Fan Kits with LED

Dimensions (mm)

Model	Diffuser Cut-Out	A	B	C	D	E	F	G	H
EL150	165	200	143	170	185	200	200	74	148
EL125	145	125	155	125	195	155	170	74	118
EL100	115	130	155	90	100	27	140	74	98

Note: Diffuser cut-out size is a nominal diameter for a circular cut-out.

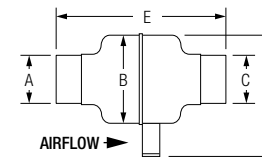
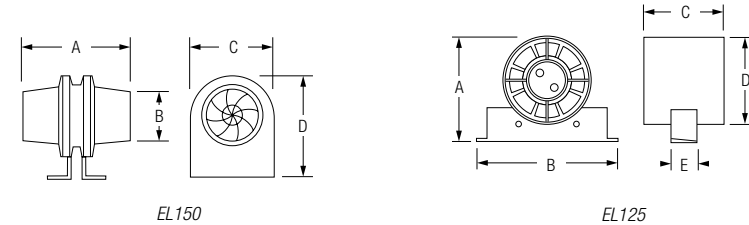

EL100

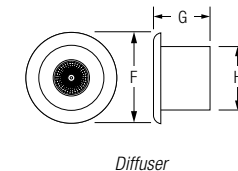

Diffuser

Technical

Model	EL150	EL125	EL100
Supply	220-240V AC, 50Hz		
LED	12V 50W		
Total Wattage	21W	23W	23W
Sound Level	38 dB(A)	41 dB(A)	45 dB(A)
Max. Operating Temp	45°C	40°C	40°C
IP Rating	IP44	IPX4	IPX4
Duct	5m Flexible PVC	4m Flexible PVC	3m Flexible PVC



Inline Extraction Fan Kits with Halogen Lamp

These high efficiency inline fans are designed to provide higher levels of extraction for larger bathrooms and the halogen lamp adds light directly above your steam source (e.g. shower or bath). Mixed flow fans provide users with a two fan speed option. 5 year warranty.

Classic Standard Profile	Duct (mm)	Fan Type	Max. Fan Watts (W)	Max. Fan Pressure (Pa)	Free Air Fan Performance		Specific Fan Power (W/l/s)	Interior Grille	Exterior Grille	Switching	Model	Order Code
					(l/s)	(m ³ /hr)						
	150	EC Axial	18	91	105	380	0.17	Round White	Eggcrate White	Standard	EL150S	FAN0803
										Timer	EL150T	FAN0804
	125	Axial	20	35	36	130	0.56	Round White	Eggcrate White	Standard	EL125S	FAN2037
										Timer	EL125T	FAN2038
	100	Centrifugal	20	120	31	110	0.65	White	White	Timer	EL100T	FAN0438

Note: Installed system performance is always influenced by duct length and layout

Switching Options

Standard Remote switch (not supplied).

Timer Remote switch (not supplied). Fan continues operating for preset time after switching off. 150mm models include fixed 7 minute timer. 125mm and 100mm model timers are 1-20 minute adjustable and require permanent and switched phase.

Accessories

Diffuser with Halogen Lamp (12V 50W)	Model	White
	EL150	DCT1169
	EL100	DCT0360

Inline Extraction Fan Kits with Halogen Lamp

Dimensions (mm)

Model	Diffuser Cut-Out	A	B	C	D	E	F	G	H
EL150	165	200	143	170	185	200	200	74	148
EL125	145	125	155	125	195	155	170	74	118
EL100	115	130	155	90	100	27	140	74	98

Note: Diffuser cut-out size is a nominal diameter for a circular cut-out.

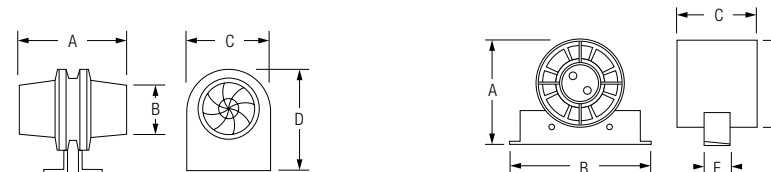

EL150

EL125

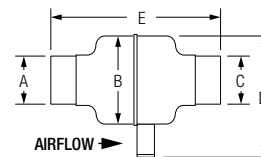

EL100

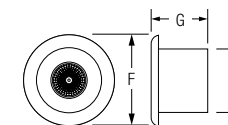

Diffuser

Technical

Model	EL150	EL125	EL100
Supply	220-240V AC, 50Hz		
Halogen Lamp	12V 50W		
Total Wattage	68W	70W	70W
Sound Level	38 dB(A)	41 dB(A)	45 dB(A)
Max. Operating Temp	45°C	40°C	40°C
IP Rating	IP44	IPX4	IPX4
Duct	5m Flexible PVC	4m Flexible PVC	3m Flexible PVC



125mm BATHROOM FANS

& 150mm HIGH STEAM BATHROOM & KITCHEN FANS



Quiet fans range now includes
NEW HUMIDITY MODELS

Model	Standard Switching	Timer Switching	Humidity Control
125mm Wall/Ceiling Mount Fans	FAN7180	FAN7181	FAN7182
150mm Wall/Ceiling Mount Fans	FAN7183	FAN7184	FAN7185

The new high-pressure and energy-efficient QUIET fans have ultra-high airflow without nuisance noise and are designed to be ducted straight through a bathroom or kitchen exterior wall. 5 year warranty.

Designer QUIET	Duct (mm)	Fan Type	Max. Fan Watts (W)	Max. Fan Pressure (Pa)	Free Air Fan Performance		Specific Fan Power (W/l/s)	Sound dB(A)	Switching	Order Code
					(l/s)	(m ³ /hr)				
	150	Axial	22	138	114	410	0.19	41	Standard	FAN7183
									Timer	FAN7184
									Humidity Control	FAN7185
	125	Axial	15	68	54	194	0.28	38	Standard	FAN7180
									Timer	FAN7181
									Humidity Control	FAN7182

Note: Installed system performance is always influenced by duct length and layout

Switching Options

Standard Remote switch (not supplied).

Timer Remote switch (not supplied). Fan continues operating for preset time after switching off. Timers are 2-30 minute adjustable and require permanent and switched phase.

Humidity Remote switch (not supplied). The humidity control models come with an advanced inbuilt humidity automation controller.

Dimensions (mm)

Model	Cut-Out Size	A	B	C	D
FAN7183 FAN7184 FAN7185	173	227	30.5	111	Ø146
FAN7180 FAN7181 FAN7182	140	185	29	100	Ø120

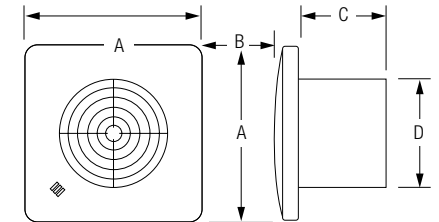



Technical

Model	FAN7183	FAN7184	FAN7185	FAN7180	FAN7181	FAN7182
Supply	220-240V AC, 50Hz					
Max. Operating Temp	40°C					
IP Rating	IPX4					



Wall/Ceiling Fans - Cucina

CUCINA is a powerful 2 boost speed centrifugal extraction fan with a washable metal grease filter. The installation selectable speeds are suitable for kitchens (high speed) or laundries (medium). The fan is G4 and Healthy Homes compliant for kitchen extract ventilation levels (when installed in through wall applications at kitchen boost level) and also has a low speed for long term trickle ventilation. A plate fascia and fine filter kit is also available as a front grille alternative for laundry installations. 5 year warranty.

Designer CUCINA	Duct (mm)	Fan Type		Fan Speed and Application		Max. Fan Watts (W)	Max. Fan Pressure (Pa)	Free Air Fan Performance		Specific Fan Power (W/l/s)	Sound dB(A)	Switching	Order Code
								(l/s)	(m ³ /hr)				
  	100	Centrifugal	High Medium	Kitchen Laundry	60	236	73	263	0.82	52	Pull Cord	FAN7201	
					41	140	39	140	1.05	38			
					Plate Fascia and Fine Filter Kit (order separately)								
Replacement Washable Metal Grease Filter (order separately)										DCT4562			

Note: Installed system performance is always influenced by duct length and layout

Dimensions (mm)

A	B	C	D	E	F
231	261	137	79	58	Ø98

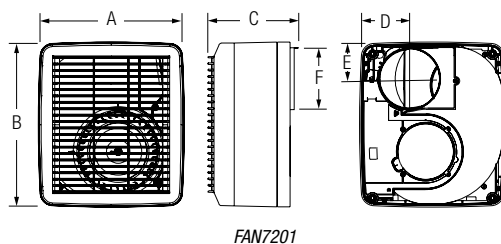

Technical

Supply	220-240V AC, 50Hz
Max. Operating Temp	40°C
IP Rating	IPX4

Wall/Ceiling Fans - Eco

Eco fans deliver up to 67% energy savings and fan life is extended is due to high quality ball bearing motors.

With a slim 19mm profile, these axial fans blend in with the wall or ceiling surface to provide an unobtrusive installation and can be connected to an appropriate duct run to exhaust outside.

Models include 2 speeds selectable at installation to customise the fan to each application and come complete with a blue LED to indicate operation.

Classic ECO	Duct (mm)	Max. Fan Watts (W)	Max. Fan Pressure (Pa)	Free Air Fan Performance		Specific Fan Power (W/l/s)	Sound dB(A)	Switching	Model	Order Code
				(l/s)	(m ³ /hr)					
	150	5	20	46	165	0.11	35	Timer	LCS150T	FAN2214
		8.2	32	67	241	0.12	43			

* 1 of 2 speeds selectable at installation

- 19mm stylish low profile grille
- Downstream airflow guide vanes for improved pressure development
- 1 of 2 speeds selectable at installation
- High quality ball bearing motors
- Modern aesthetics, includes blue LED "on light"

Switching Options

Standard Remote switch (not supplied).

Timer Remote switch (not supplied). Fan continues operating for preset time (1-20 minute adjustable) after switching off. Permanent phase, switched phase and neutral required.

Fan Wattage Comparison

Duct	Fan	Model	Watts
150mm	Manrose Pro-Series Wall/Ceiling Fan	XFLP150	25.0
	Eco Wall/Ceiling Fan	LCS150	8.2
Energy Saving			16.8

Technical

Supply	220-240V AC, 50Hz
IP Rating	IPX4
Warranty	5 years



Wall/Ceiling Fans - SELV and Auto Shutter

These axial fans are designed for easy installation and efficient operation. SELV (safety extra low voltage) models are designed for use in wet area zones 1, 2 and 3 and incorporate a 12V AC motor and a 12V AC isolating transformer. Auto shutter models have automated backflow prevention vanes. 5 year warranty.

SELV (Safety Extra Low Voltage)

Pro-Series Low Profile	Duct (mm)	Fan Type	Max. Fan Watts (W)	Max. Fan Pressure (Pa)	Free Air Fan Performance		Specific Fan Power (W/l/s)	Sound dB(A)	Fascia	Switching	Model	Order Code
					(l/s)	(m³/hr)						
	150	Axial	20	60	101	364	0.20	40	Square	Standard	XFLP150SLV	FAN5892
											Round	XFLP150CLV
	125	Axial	20	35	36	130	0.56	41	Square	Standard	XFLP125SLV	FAN5886
											Round	XFLP125CLV

Classic Standard Profile	Duct (mm)	Fan Type	Max. Fan Watts (W)	Max. Fan Pressure (Pa)	Free Air Fan Performance		Specific Fan Power (W/l/s)	Sound dB(A)	Fascia	Switching	Model	Order Code
					(l/s)	(m³/hr)						
	150	Axial	20	60	101	364	0.20	40	Square	Standard	XF150LV	FAN5896
	125	Axial	20	35	36	130	0.56	41	Square	Standard	XF125LV	FAN5890
	100	Axial	20	20	23	85	0.87	41	Square	Standard	XF100LV	FAN5883

Auto Shutter

Classic Standard Profile	Duct (mm)	Fan Type	Max. Fan Watts (W)	Max. Fan Pressure (Pa)	Free Air Fan Performance		Specific Fan Power (W/l/s)	Sound dB(A)	Fascia	Switching	Model	Order Code
					(l/s)	(m³/hr)						
	300	Axial	82	60	306	1100	0.27	60	Square	Standard	XFS300A	FAN2041
	230	Axial	45	50	152	550	0.30	50	Square	Standard	XFS230A	FAN0346
										Standard	XF150A	FAN0121
	150	Axial	25	60	87	313	0.29	40	Square	Pull Cord	XF150AP	FAN0122
										Timer	XF150AT	FAN0123

Note: Installed system performance is always influenced by duct length and layout

Switching Options

Standard Remote switch (not supplied).

Timer Remote switch (not supplied). Fan continues operating for preset time after switching off.

All timers are 1-20 minute adjustable and require permanent and switched phase.

Pull Cord Integral part of fan.

Accessories

Fascia	Model	Duct	Round		Square		
			White	Chrome	White	Satin Silver	Chrome
	XFLP	150mm	FAN0750	-	FAN0749	FAN2071	FAN0598
		125mm	FAN0748	FAN0757	FAN0747	FAN2068	FAN0755

Wall/Ceiling Fans - SELV and Auto Shutter

Dimensions (mm)

Model	Cut-Out Size	A	B	C	D	E
XFLP150S	173	191	10	122	150	-
XFLP150C	173	198	10	122	150	-
XFLP125S	140	161	10	122	118	-
XFLP125C	140	165	10	122	118	-
XFS300	310	362	156	81	75	300
XFS230	265	286	141	75	66	230
XF150	160	200	27	74	148	-
XF125	140	168	27	74	118	-
XF100	112	155	27	74	98	-
XF150A XF150AP	160	200	55	90	148	-

Please note: Fan cut-out size is a nominal diameter.

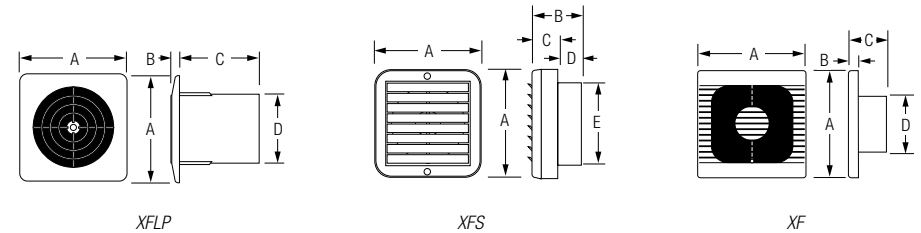

Technical

Supply	SELV	12V AC
	Auto Shutter	220-240V AC, 50Hz
Max. Operating Temp		50°C
IP Rating		IPX4



Wall/Ceiling Fans - Standard

These fans are designed for easy installation and efficient operation. 5 year warranty.

Pro-Series Low Profile	Duct (mm)	Fan Type	Max. Fan Watts (W)	Max. Fan Pressure (Pa)	Free Air Fan Performance		Specific Fan Power (W/l/s)	Sound dB(A)	Fascia	Switching	Model	Order Code
					(l/s)	(m ³ /hr)						
	150	Axial	20	60	101	364	0.20	40	Square	Standard	XFLP150SS	FAN0594
									Round	Standard	XFLP150CS	FAN0609
									Square	Timer	XFLP150ST	FAN0595
									Round	Timer	XFLP150CT	FAN0610
	125	Axial	20	35	36	130	0.56	41	Square	Standard	XFLP125SS	FAN0589
									Round	Standard	XFLP125CS	FAN0604
Square									Timer	XFLP125ST	FAN0590	
Round									Timer	XFLP125CT	FAN0605	

Classic Standard Profile	Duct (mm)	Fan Type	Max. Fan Watts (W)	Max. Fan Pressure (Pa)	Free Air Fan Performance		Specific Fan Power (W/l/s)	Sound dB(A)	Fascia	Switching	Model	Order Code	
					(l/s)	(m ³ /hr)							
	300	Axial	82	60	306	1100	0.27	60	Square	Standard	XFS300S	FAN2040	
	230	Axial	45	50	152	550	0.30	50	Square	Standard	XFS230S	FAN0374	
											Standard	XF150S	FAN0120
												Pull Cord	XF150P
	150	Axial	25	60	101	364	0.25	40	Square	Timer	XF150T	FAN0127	
										PIR	XF150PIR	FAN0124	
										Standard	XF125S	FAN0072	
	125	Axial	20	35	36	130	0.56	41	Square	Pull Cord	XF125P	FAN0074	
										Timer	XF125T	FAN0075	
										Standard	XF100S	FAN0046	
	100	Axial	20	20	23	85	0.87	41	Square	Pull Cord	XF100P	FAN0047	
										Timer	XF100T	FAN0048	

Note: Installed system performance is always influenced by duct length and layout

Switching Options

- Standard** Remote switch (not supplied).
- Timer** Remote switch (not supplied). Fan continues operating for preset time after switching off. All timers are 1-20 minute adjustable and require permanent and switched phase.
- Pull Cord** Integral part of fan.

Accessories

Fascia	Model	Duct	Round		Square		
			White	Chrome	White	Satin Silver	Chrome
	XFLP	150mm	FAN0750	-	FAN0749	FAN2071	FAN0598
		125mm	FAN0748	FAN0757	FAN0747	FAN2068	FAN0755

Wall/Ceiling Fans - Standard

Dimensions (mm)

Model	Cut-Out Size	A	B	C	D	E
XFLP150S	173	191	10	122	150	-
XLFP150C	173	198	10	122	150	-
XLFP125S	140	161	10	122	118	-
XLFP125C	140	165	10	122	118	-
XFS300	310	362	156	81	75	300
XFS230	265	286	141	75	66	230
XF150	160	200	27	74	148	-
XF150PIR	160	200	55	90	200	-
XF125	140	168	27	74	118	-
XF100	112	155	27	74	98	-

Please note: Fan cut-out size is a nominal diameter.

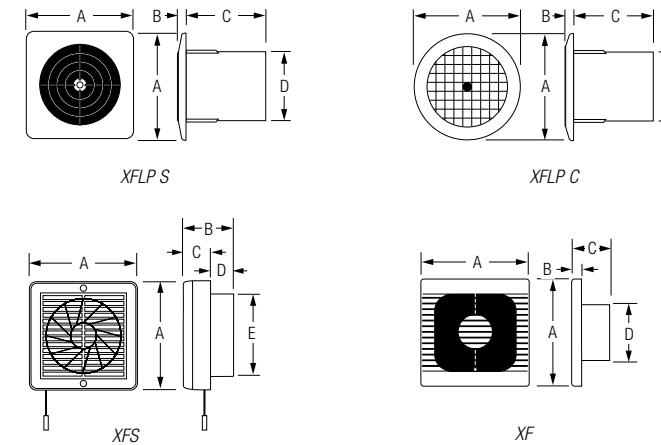

Technical

Supply	220-240V AC, 50Hz
Max. Operating Temp	50°C
IP Rating	IPX4



125mm BATHROOM FAN KITS

& 150mm

HIGH STEAM BATHROOM & KITCHEN FAN KITS



Quiet fan kits range now includes
NEW HUMIDITY MODELS

Model	Standard Switching	Timer Switching	Humidity Control
125mm Through Wall Fan Kits	FAN7187	FAN7188	FAN7189
150mm Through Wall Fan Kits	FAN7190	FAN7191	FAN7192

The new high-pressure and energy-efficient QUIET fan kits have ultra-high airflow without nuisance noise and are designed to be ducted straight through a bathroom or kitchen exterior wall. All kits include a weatherproof cowl. 5 year warranty.

Designer Standard Profile	Duct (mm)	Fan Type	Max. Fan Watts (W)	Max. Fan Pressure (Pa)	Free Air Fan Performance		Specific Fan Power (W/l/s)	Sound dB(A)	Switching	Order Code
					(l/s)	(m ³ /hr)				
	150	Axial	22	138	114	410	0.19	41	Standard	FAN7190
									Timer	FAN7191
									Humidity Control	FAN7192
	125	Axial	15	68	54	194	0.28	38	Standard	FAN7187
									Timer	FAN7188
									Humidity Control	FAN7189

Note: Installed system performance is always influenced by duct length and layout

Switching Options

Standard Remote switch (not supplied).

Timer Remote switch (not supplied). Fan continues operating for preset time after switching off. Timers are 2-30 minute adjustable and require permanent and switched phase.

Humidity Remote switch (not supplied). The humidity control models come with an advanced inbuilt humidity automation controller.

Dimensions (mm)

Model	Cut-Out Size	A	B	C	D	E	F	G	H
FAN7190 FAN7191 FAN7192	173	174	30	150	375	146	111	30.5	227
FAN7187 FAN7188 FAN7189	140	160	30	125	375	120	100	29	185

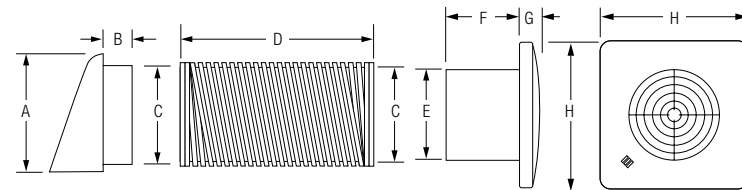

Technical

Supply	220-240V AC, 50Hz
Max. Operating Temp	40°C
IP Rating	IPX4
Exterior Grille	Weatherproof Cowl
Duct	Aluminium Semi-Rigid
Duct Length	375mm





Through Wall Fan Kits - Intelligent Sensing Automation

For continuous operation compliance only.

The Manrose Genius is the new generation of unitary fans. Following installation home owners automatically have a ventilation system offering a wide range of standard default operating settings which can be easily customised via an intuitive App. Includes energy efficient DC motor. 5 year warranty.

The Manrose IntelliVent Humidity and IntelliVent Temperature fans are sensor operated complete with adjustable speed control and LED function indication. An easy to access control panel provides for simple and exact adjustment of settings. Includes energy efficient DC motor. 5 year warranty.

Designer GENIUS	Duct (mm)	Fan Type	Max. Fan Watts (W)	Max. Fan Pressure (Pa)	Free Air Fan Performance		Specific Fan Power (W/l/s)	Sound dB(A)	Fascia	Switching	Order Code
					(l/s)	(m ³ /hr)					
	100	DC Axial	4	30	30	108	0.13	17-20	Round	App Control	FAN6844
Designer INTELLIVENT	Duct (mm)	Fan Type	Max. Fan Watts (W)	Max. Fan Pressure (Pa)	Free Air Fan Performance		Specific Fan Power (W/l/s)	Sound dB(A)	Fascia	Switching	Order Code
					(l/s)	(m ³ /hr)					
	100 125	DC Axial	8	21	37	134	0.22	12-29	Rectangle	Auto Sense Humidity Auto Sense Temperature	FAN5901 FAN6051

Note: Installed system performance is always influenced by duct length and layout

Accessories

Model	Description	Order Code
	Through Wall and Backdraught Kit Ø 100 x 310mm (using 98mm adapter) Ø 125 x 310mm (using 118mm adapter)	DCT4149 DCT4150
INTELLIVENT HUMIDITY INTELLIVENT TEMPERATURE 	Cover Plate - White 202 x 152mm	DCT4151
	Internal Through Wall Kit Ø 100 x 100mm (using 98mm adapter)	DCT4152

Through Wall Fan Kits - Intelligent Sensing Automation

Dimensions (mm)

Model	A	B	C	D
Genius	177	99	21	60
IntelliVent	202	152	31	-

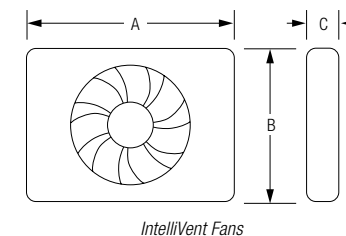
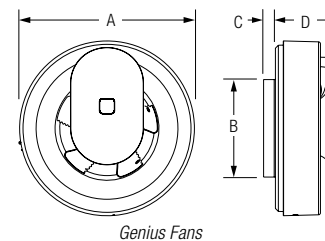

Technical

Model	Genius	IntelliVent		
		100mm	125mm	
Supply	220-240V AC, 50Hz	220-240V AC, 50Hz		
Max. Operating Temp	40°C	40°C		
Fan Speed	Low Trickle	10 l/s	-	
	High Trickle	16 l/s	-	
	Boost	30 l/s	-	
	Constant	-	12 l/s, 42m ³ /hr	12 l/s, 55m ³ /hr
	Silent	-	21 l/s, 74m ³ /hr	24 l/s, 86m ³ /hr
	Max	-	30 l/s, 107m ³ /hr	30 l/s, 134m ³ /hr
IP Rating	IP44	IPX4	IPX4	

General Information

Model	App Controls
Genius	Bluetooth
	Light Level Sensor
	Variable Speed
	Timer
	Heat Transfer
	RH%

Through Wall Fan Kits - SELV and Auto Shutter



These fan kits are easy to install and are designed to be ducted straight through an exterior wall. SELV (safety extra low voltage) fans are for use in wet area zones 1, 2 and 3 and incorporate a 12V AC motor and a 12V AC isolating transformer. Auto shutter models have automated backflow prevention vanes. All kits include a weatherproof cowl. 5 year warranty.

SELV (Safety Extra Low Voltage)

Pro-Series Low Profile	Duct (mm)	Fan Type	Max. Fan Watts (W)	Max. Fan Pressure (Pa)	Free Air Fan Performance		Specific Fan Power (W/l/s)	Sound dB(A)	Fascia	Switching	Model	Order Code
					(l/s)	(m³/hr)						
	150	Axial	20	60	101	364	0.20	40	Square	Standard	XPLP150SLV	FAN5894
											Round	XPLP150CLV
	125	Axial	20	35	36	130	0.56	41	Square	Standard	XPLP125SLV	FAN5887
											Round	XPLP125CLV

Classic Standard Profile	Duct (mm)	Fan Type	Max. Fan Watts (W)	Max. Fan Pressure (Pa)	Free Air Fan Performance		Specific Fan Power (W/l/s)	Sound dB(A)	Fascia	Switching	Model	Order Code
					(l/s)	(m³/hr)						
	150	Axial	20	60	101	364	0.20	40	Square	Standard	XP150LV	FAN5895
	125	Axial	20	35	36	130	0.56	41	Square	Standard	XP125LV	FAN5889
	100	Axial	20	20	23	85	0.87	41	Square	Standard	XP100LV	FAN5882

Auto Shutter

Classic Standard Profile	Duct (mm)	Fan Type	Max. Fan Watts (W)	Max. Fan Pressure (Pa)	Free Air Fan Performance		Specific Fan Power (W/l/s)	Sound dB(A)	Fascia	Switching	Model	Order Code
					(l/s)	(m³/hr)						
	300	Axial	82	60	306	1100	0.27	60	Square	Standard	XPS300A	FAN2043
	230	Axial	45	50	152	550	0.30	50	Square	Standard	XPS230A	FAN0348
	150	Axial	25	60	87	313	0.29	40	Square	Standard	XP150A	FAN0136
										Pull Cord	XP150AP	FAN0137
										Timer	XP150AT	FAN0138

Note: Installed system performance is always influenced by duct length and layout

Switching Options

Standard Remote switch (not supplied).

Timer Remote switch (not supplied). Fan continues operating for preset time after switching off. 150mm models include fixed 7 minute timer. 125mm and 100mm model timers are 1-20 minute adjustable and require permanent and switched phase.

Pull Cord Integral part of fan.

Accessories

Fascia	Model	Duct	Round		Square		
			White	Chrome	White	Satin Silver	Chrome
	XFLP	150mm	FAN0750	-	FAN0749	FAN2071	FAN0598
		125mm	FAN0748	FAN0757	FAN0747	FAN2068	FAN0755

Through Wall Fan Kits - SELV and Auto Shutter

Dimensions (mm)

Model	Cut-Out Size	A	B	C	D	E	F	G	H
XPLP150	173	174	30	150	375	150	132	10	191
XPLP125	140	160	30	125	375	118	128	10	161
XPS300	310	350	50	230	375	300	156	81	362
XPS230	265	286	30	250	375	230	141	75	286
XP150	160	174	30	150	375	148	74	27	200
XP150A	160	174	30	150	375	148	90	55	200
XP125	140	160	30	125	375	118	74	27	168
XP100	112	138	30	100	375	98	74	27	155

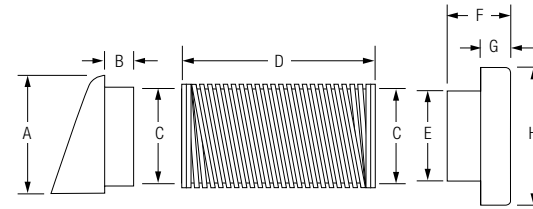

XPLP / XP

Technical



Model	XPLP	XPS	XP
Supply	SELV	12V AC	
	Auto Shutter	220-240V AC, 50Hz	
Max. Operating Temp	50°C	50°C	50°C
IP Rating	IPX4	IPX4	IPX4
Exterior Grille	Weatherproof Cowl	White Fixed Grille	Weatherproof Cowl
Duct	Aluminium Semi-Rigid	Aluminium Semi-Rigid	Aluminium Semi-Rigid
Duct Length	375mm	375mm	375mm



Through Wall Fan Kits - Standard

These efficient fan kits are easy to install and are designed to be ducted straight through an exterior wall. All fan kits include a weatherproof cowl. Models featuring a low profile fascia offer a more stylish and unobtrusive installation into any wall and are supplied with an exterior grille. Other models are supplied with an exterior cowl. 5 year warranty.

Pro-Series Low Profile	Duct (mm)	Fan Type	Max. Fan Watts (W)	Max. Fan Pressure (Pa)	Free Air Fan Performance		Specific Fan Power (W/l/s)	Sound dB(A)	Fascia	Switching	Model	Order Code
					(l/s)	(m³/hr)						
	150	Axial	20	60	101	364	0.20	40	Square	Standard	XPLP150SS	FAN0621
										Timer	XPLP150ST	FAN0623
	125	Axial	20	35	36	130	0.56	41	Square	Standard	XPLP125SS	FAN0614
										Timer	XPLP125ST	FAN0615

Classic Standard Profile	Duct (mm)	Fan Type	Max. Fan Watts (W)	Max. Fan Pressure (Pa)	Free Air Fan Performance		Specific Fan Power (W/l/s)	Sound dB(A)	Fascia	Switching	Model	Order Code
					(l/s)	(m³/hr)						
	300	Axial	82	60	306	1100	0.27	60	Square	Standard	XPS300S	FAN2042
	230	Axial	45	50	152	550	0.30	50	Square	Standard	XPS230S	FAN0455
	150	Axial	25	60	101	364	0.25	40	Square	Standard	XP150S	FAN0135
										Pull Cord	XP150P	FAN0140
	125	Axial	20	35	36	130	0.56	41	Square	Timer	XP150T	FAN0141
										Standard	XP125S	FAN0080
	100	Axial	20	20	23	85	0.87	41	Square	Pull Cord	XP125P	FAN0082
										Timer	XP125T	FAN0083
										Standard	XP100S	FAN0053
										Pull Cord	XP100P	FAN0054
Timer	XP100T	FAN0055										

Note: Installed system performance is always influenced by duct length and layout

Switching Options

- Standard** Remote switch (not supplied).
- Timer** Remote switch (not supplied). Fan continues operating for preset time after switching off. 150mm models include fixed 7 minute timer. 125mm and 100mm model timers are 1-20 minute adjustable and require permanent and switched phase.
- Pull Cord** Integral part of fan.

Accessories

Fascia	Model	Duct	Round		Square		
			White	Chrome	White	Satin Silver	Chrome
	XFLP	150mm	FAN0750	-	FAN0749	FAN2071	FAN0598
		125mm	FAN0748	FAN0757	FAN0747	FAN2068	FAN0755

Through Wall Fan Kits - Standard

Dimensions (mm)

Model	Cut-Out Size	A	B	C	D	E	F	G	H
XPLP150	173	174	30	150	375	148	132	10	191
XPLP125	140	160	30	125	375	123	128	10	161
XPS300	310	350	50	230	375	298	156	81	362
XPS230	265	286	30	250	375	248	141	75	286
XP150	160	174	30	150	375	148	74	27	200
XP125	140	160	30	125	375	123	74	27	168
XP100	112	138	30	100	375	98	74	27	155

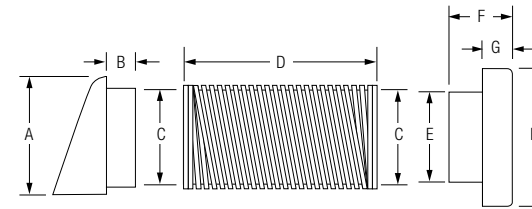

XPLP / XP

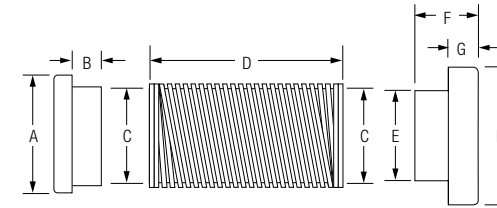

XPS

Technical

Model	XPLP	XPS	XP
Supply	220-240V AC, 50Hz		
Max. Operating Temp	50°C	50°C	50°C
IP Rating	IPX4	IPX4	IPX4
Exterior Grille	Weatherproof Cowl	White Fixed Grille	Weatherproof Cowl
Duct	Aluminium Semi-Rigid	Aluminium Semi-Rigid	Aluminium Semi-Rigid
Duct Length	375mm	375mm	375mm



Window Fans - SELV and Auto Shutter

These fans are designed for installation situations where an existing window fan is being replaced or where there is no available external wall, or ceiling, space access. SELV fans are designed for use in wet area zones 1, 2 and 3 and incorporate a 12V AC motor and a 12V AC isolating transformer. Auto shutter models have automated backflow prevention vanes. 5 year warranty.

Safety Extra Low Voltage (SELV)

Classic Standard Profile	Duct (mm)	Fan Type	Max. Fan Watts (W)	Max. Fan Pressure (Pa)	Free Air Fan Performance		Specific Fan Power (W/l/s)	Sound dB(A)	Fascia	Switching	Model	Order Code
					(l/s)	(m³/hr)						



	100	Axial	20	20	23	85	0.87	41	Square	Pull Cord	WF100PLV	FAN5884
--	-----	-------	----	----	----	----	------	----	--------	-----------	----------	---------

Safety Extra Low Voltage (SELV) & Auto Shutter

Classic Standard Profile	Duct (mm)	Fan Type	Max. Fan Watts (W)	Max. Fan Pressure (Pa)	Free Air Fan Performance		Specific Fan Power (W/l/s)	Sound dB(A)	Fascia	Switching	Model	Order Code
					(l/s)	(m³/hr)						



	150	Axial	25	60	87	313	0.29	40	Square	Pull Cord	WF150APLV	FAN5897
--	-----	-------	----	----	----	-----	------	----	--------	-----------	-----------	---------

Auto Shutter

Classic Standard Profile	Duct (mm)	Fan Type	Max. Fan Watts (W)	Max. Fan Pressure (Pa)	Free Air Fan Performance		Specific Fan Power (W/l/s)	Sound dB(A)	Fascia	Switching	Model	Order Code
					(l/s)	(m³/hr)						



	300	Axial	82	60	306	1100	0.27	60	Square	Standard	WF300A	FAN0482
--	-----	-------	----	----	-----	------	------	----	--------	----------	--------	---------



	230	Axial	45	50	152	550	0.30	50	Square	Pull Cord	WF230AP	FAN0146
--	-----	-------	----	----	-----	-----	------	----	--------	-----------	---------	---------



	150	Axial	25	60	87	313	0.29	40	Square	Pull Cord Timer	WF150APT	FAN0109
--	-----	-------	----	----	----	-----	------	----	--------	-----------------	----------	---------



	300	Axial	82	60	280	1020	0.29	60	Square	Standard/Auto	COM300A	FAN0521
--	-----	-------	----	----	-----	------	------	----	--------	---------------	---------	---------



	300	Axial	82	60	280	1020	0.29	60	Square	Standard/Pull Cord	COM300MP	FAN0520
--	-----	-------	----	----	-----	------	------	----	--------	--------------------	----------	---------



	230	Axial	45	50	185	670	0.24	53	Square	Standard/Auto	COM230A	FAN0519
--	-----	-------	----	----	-----	-----	------	----	--------	---------------	---------	---------

Note: Installed system performance is always influenced by duct length and layout
Electrically operated louvre shutters open automatically when fan is running - prevents backdraughts.

Switching Options

Standard	Remote switch (not supplied).
Pull Cord Timer	Pull cord is integral part of fan. Fan continues operating for 7 minutes after switching off.
Pull Cord	Integral part of fan.
Standard/Auto	Remote switch (not supplied) and internal thermo-activation of shutters
Standard/Pull Cord	Remote switch (not supplied) and manual operation of shutters by pull cord

Window Fans - SELV and Auto Shutter

Dimensions (mm)

Model	Cut-Out Size	A	B	C	D
WF300	310-345	362	4-32	112	29
WF230	255-270	286	4-32	112	25
WF150	165-190mm	203	125	23	-
WF100	115-155mm	163	120	30	-
COM300	310-345	362	170	145	25
COM230	255-270	286	154	125	25

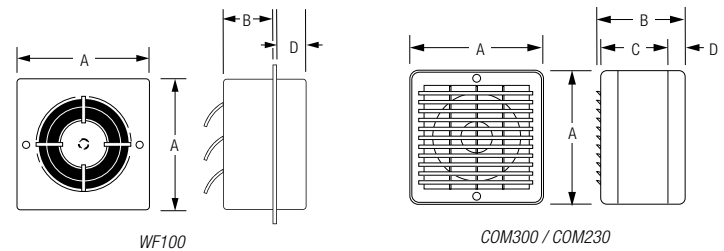
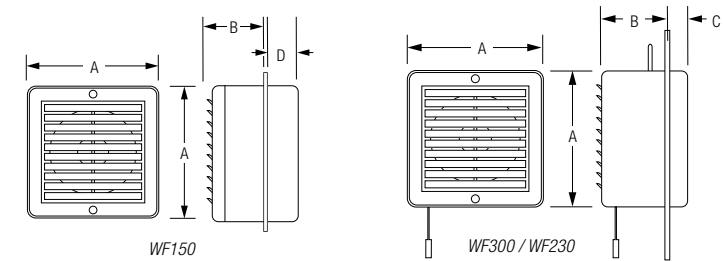



Technical

Supply	SELV	12V AC
	Auto Shutter	220-240V AC, 50Hz
Max. Operating Temp	50°C	
IP Rating	IPX4	



Window Fans - Standard

These fans are designed for installation situations where an existing window fan is being replaced or where there is no available external wall, or ceiling, space access. 5 year warranty.

Classic Standard Profile	Duct (mm)	Fan Type	Max. Fan Watts (W)	Max. Fan Pressure (Pa)	Free Air Fan Performance		Specific Fan Power (W/l/s)	Sound dB(A)	Fascia	Switching	Model	Order Code
					(l/s)	(m³/hr)						
	300	Axial	82	60	306	1100	0.27	60	Square	Pull Cord	WF300P	FAN0481
	230	Axial	45	50	152	550	0.30	50	Square	Pull Cord	WF230P	FAN0148
	100	Axial	20	20	23	85	0.87	41	Square	Pull Cord	WF100P	FAN0021

Note: Installed system performance is always influenced by duct length and layout
Electrically operated louvre shutters open automatically when fan is running - prevents backdraughts.

Switching Options

- Standard** Remote switch (not supplied).
- Pull Cord** Integral part of fan.

Window Fans - Standard

Dimensions (mm)

Model	Cut-Out Size	A	B	C	D
WF300	310-345	362	4-32	112	29
WF230	255-270	286	4-32	112	25
WF100	115-155mm	163	120	30	-

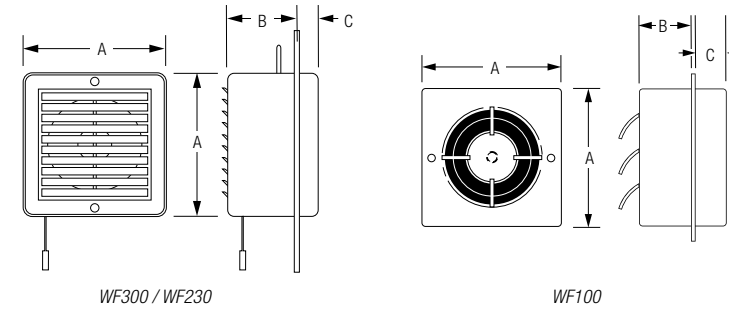

Technical

Max. Operating Temp	50°C
IP Rating	IPX4



Wall Fans - Internal and External

Internal Wall fans are designed to move air efficiently over long distances with the centrifugal fan providing quiet operation.

External wall fans are designed for use in residential and light commercial applications where a high performance, low noise solution is required. Three speed models enable further flexibility in a variety of applications. Specific applications include apartments where space is limited. 2 year warranty

Internal - Standard

Classic Standard Profile Rectangular Fascia	Duct (mm)	Fan Type	Max. Fan Watts (W)	Max. Fan Pressure (Pa)	Free Air Fan Performance		Specific Fan Power (W/l/s)	Sound dB(A)	Switching	Model	Order Code
					(l/s)	(m³/hr)					
	100	Centrifugal	45	120	31	110	1.45	45	Standard	CF200S	FAN0041

External - Standard

Classic	Duct (mm)	Fan Type	Scroll Dia. (mm)	Max. Fan Watts (W)	Max. Fan Pressure (Pa)	Free Air Fan Performance		Specific Fan Power (W/l/s)	Sound dB(A)	Switching	Model	Order Code
						(l/s)	(m³/hr)					
	150	Axial	-	48	80	73	263	0.66	48	Standard	WF150AX	FAN2303
		Centrifugal	190	65	280	109	392	0.60	60	Standard	WF150C190	FAN2301
			220	96	380	118	423	0.81	61	Standard	WF150C220	FAN2302

External - 3 Speed

Classic	Duct (mm)	Fan Type & Speed	Scroll Dia. (mm)	Max. Fan Watts (W)	Max. Fan Pressure (Pa)	Free Air Fan Performance		Specific Fan Power (W/l/s)	Sound dB(A)	Switching	Model	Order Code	
						(l/s)	(m³/hr)						
	150	Centrifugal	190	High	65	280	113	408	0.58	60	Standard	WF150C190-3	FAN2316
				Medium	57	250	94	340	0.61	56			
				Slow	55	200	77	277	0.71	46			
		Centrifugal	220	High	96	380	136	493	0.71	61	Standard	WF150C220-3	FAN2317
				Medium	69	340	113	408	0.61	56			
				Slow	60	280	94	340	0.64	50			

Note: Installed system performance is always influenced by duct length and layout

Switching Options

Standard Remote switch (not supplied).

Wall Fans - Internal and External

Dimensions (mm)

Model	A	B	C	D	E	F	G
CF200	65	260	185	135	90	45	98
WF150	305	110	369	-	-	-	-

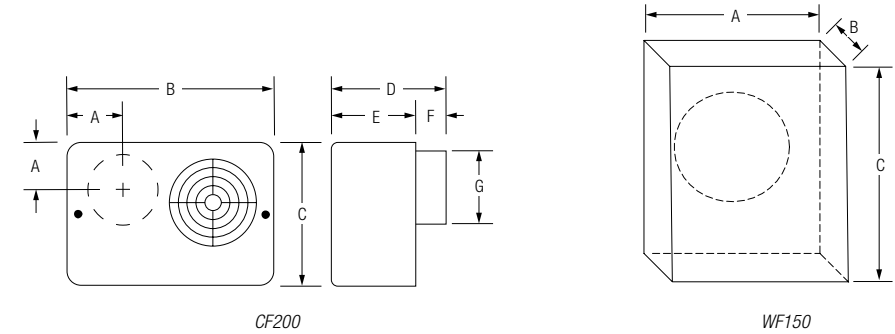

Technical

Model	CF200	WF150
Supply	220-240V AC, 50Hz	
Sound Level	45 dB(A)	
Max. Operating Temp	50°C	40°C
IP Rating	IPX4	IPX3

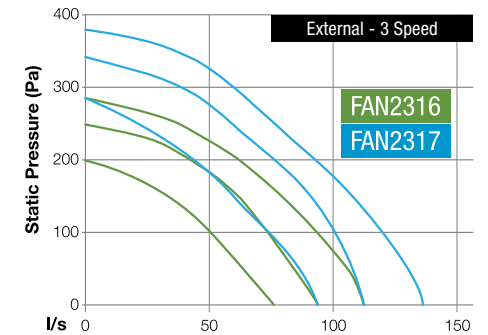
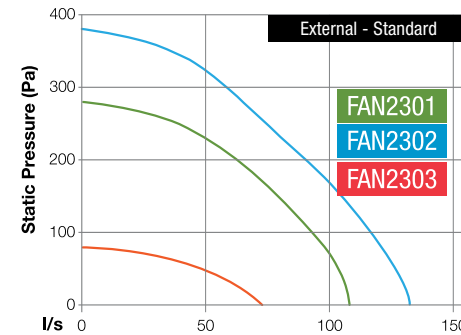

Heater-Fan-Light Systems

These multi-function systems are designed to meet the higher operational demands of both small and large bathrooms. Fans incorporate a unique anti-condensate design and efficient heating system. All systems are supplied with duct, grille and wall switch. 5 year warranty.

Designer Low Profile	Duct (mm)	Fan Type	Total Watts (W)	Max. Fan Pressure (Pa)	Free Air Fan Performance		Heating	Fascia	Order Code
					(l/s)	(m³/hr)			
	150	2 x Centrifugal	2115	145	106	380	2 Level PTC 1100W/2000W	White	FAN7020
								Black	FAN7021
	150	Centrifugal	1100	146	69	248	1 x 1000W Halogen	White	FAN6577
	150	Centrifugal	1080	146	99	356	1 x 1000W Halogen	White	FAN5876
Pro-Series Vivo	Duct (mm)	Fan Type	Total Watts (W)	Max. Fan Pressure (Pa)	Free Air Fan Performance		Heating	Fascia	Order Code
	125	Centrifugal	2100	115	92	330	2 Level PTC 1400W/2000W	White	FAN7291

Note: Installed system performance is always influenced by duct length and layout

Heater-Fan-Light Systems

Dimensions (mm)

Model	Cut-Out Size	A	B	C	D	E	F	G
FAN7020 FAN7021	523 x 345	537	165	370	192	120	340	500
FAN6577	470 x 320	350	150	200	500	-	-	-
FAN5876	470 x 320	350	150	200	500	-	-	-
FAN7291	590 x 320	630	133	350	145	95	313	585

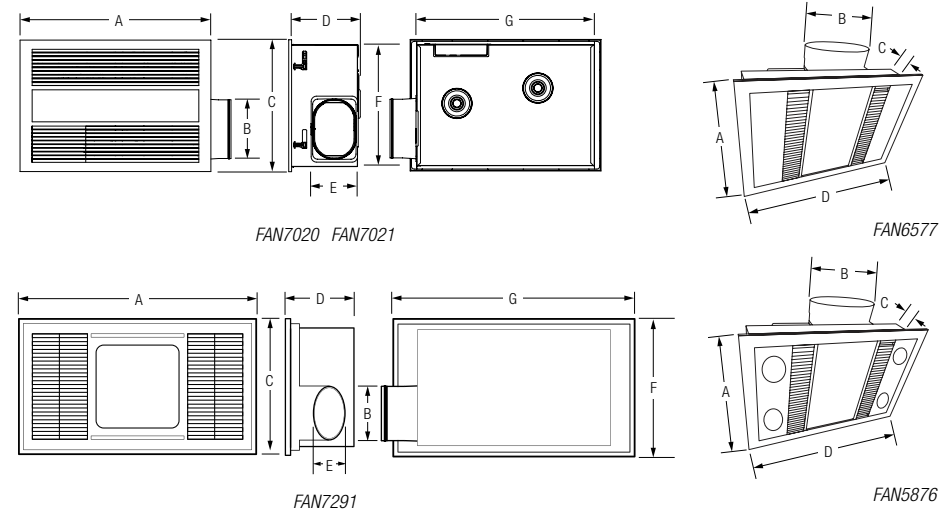

Technical

Model	FAN7020 FAN7021	FAN6577	FAN5876	FAN7291
Supply	220-240V AC, 50Hz			
Max. Load	2115W	1100W	1080W	2100W
Light	20W Panel 4000K 1500 lm	2 x 12W LED Panels 3000, 4500K, 6000K	4 x 4W LED GU10 LED downlight 3000K 38°C	20W Panel 4000K 1900 lm
Switch Plate	5-Way (supplied)	3-Way (supplied)	3-Way (supplied)	4-Way (supplied)
Max. Operating Temp	40°C	40°C	40°C	50°C
IP Rating	IPX2	IPX2	IPX2	IPX2
Exterior Grille	150mm Fixed Louvre	150mm Eggcrate	150mm Eggcrate	150mm Eggcrate
Duct	3m x 150mm	3m x 150mm	3m x 150mm	3m x 125mm



Heat-Fan-Light Systems / Heat-Light Systems

These multi-function Heat-Fan-Light systems are designed to meet the higher operational demands of both small and large bathrooms. Fans incorporate a unique anti-condensate design and efficient LED centre lamps. All systems are supplied with duct, grille and wall switch. 5 year warranty.

The FAN2200 Heat-Light systems is designed to provide instant heat and additional lighting. A 150mm inline extraction fan kit, or Blue Jet fan and ducting combination, along with a 150-100mm reducer, can be added for a complete HEAT-FAN-LIGHT solution. 5 year warranty.

Heat-Fan-Light Systems									
Designer SATIN Low Profile	Duct (mm)	Fan Type	Total Watts (W)	Max. Fan Pressure (Pa)	Free Air Fan Performance		Heat Lamps	Fascia	Order Code
					(l/s)	(m³/hr)			
	125	Centrifugal	1138	TBC	84	303	4 x 275W	White	FAN6882
								Silver	FAN6883
	125	Centrifugal	588	71	75	270	2 x 275W	White	FAN6880
								Silver	FAN6881
Pro-Series Low Profile	Duct (mm)	Fan Type	Total Watts (W)	Max. Fan Pressure (Pa)	Free Air Fan Performance		Heat Lamps	Fascia	Order Code
					(l/s)	(m³/hr)			
	125	Centrifugal	1180	83	60	216	4 x 275W	White	FAN0995
								White	FAN0940
	125	Centrifugal	635	79	50	180	2 x 275W	White	FAN0940
								White	FAN0940
Classic Standard Profile	Duct (mm)	Fan Type	Total Watts (W)	Max. Fan Pressure (Pa)	Free Air Fan Performance		Heat Lamps	Fascia	Order Code
					(l/s)	(m³/hr)			
	100	Centrifugal	670	79	35	126	2 x 275W	White	FAN2162
								White	FAN2162

Note: Installed system performance is always influenced by duct length and layout

Heat-Light Systems ¹⁾					
Classic Standard Profile	Duct (mm)	Total Watts (W)	Heat Lamps	Fascia	Order Code
	100	650	2 x 275W	White	FAN2200

1) Note: Heat and light unit only - ready for the addition of an inline fan system (Order separately).

Accessories

Description	Chrome
275W Heat Lamp	LHT0081
LED Replacement Lamp for SATIN Units	LHT1107
LED Replacement Lamp for Pro-Series and Classic Units	LHT0211

Note: Free Air Fan Performances for FAN0995, FAN0940 and FAN2162 are actually installed system rates for 3 metres of duct, one 90 degree bend and one external grille.

Heat-Fan-Light Systems / Heat-Light Systems

Dimensions (mm)

Model	Cut-Out Size	A	B	C	D
FAN6882 FAN6883	320 x 320	370	125	210	370
FAN6880 FAN6881	375 x 202	419	125	198	244
FAN0995	300 x 300	338	125	170	338
FAN0940	390 x 220	435	125	185	260
FAN2162 FAN2200	390 x 220	450	100	195	250

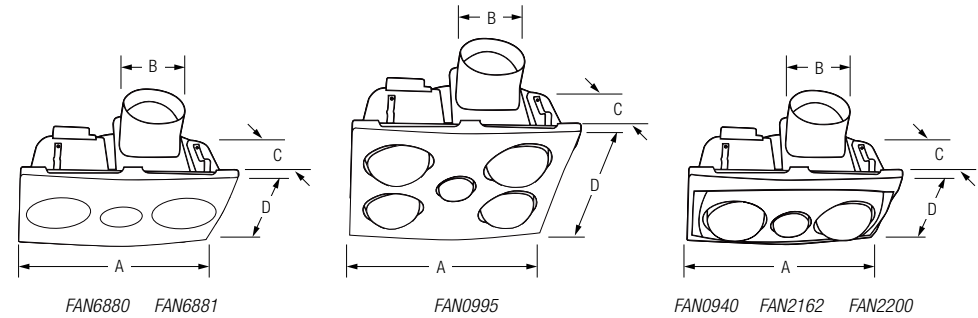
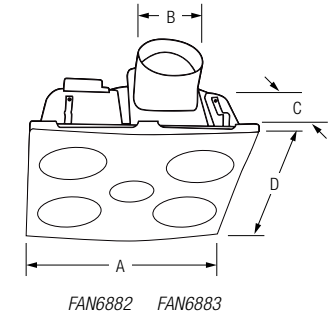

Technical

Model	FAN6882 FAN6883	FAN6880 FAN6881	FAN0995	FAN0940	FAN2162	FAN2200
Supply	220-240V AC, 50Hz					
Light	LED 4000K	LED 4000K	LED 3000K	LED 3000K	LED 3000K	LED 3000K
Light Wattage	10W	10W	4.5W	4.5W	8W	8W
Switch Plate	4-Way (supplied)	3-Way (supplied)	4-Way (supplied)	3-Way (supplied)	3-Way (supplied)	2-Way (supplied)
Max. Operating Temp	40°C	40°C	40°C	40°C	40°C	40°C
IP Rating	IPX4	IPX4	IPX4	IPX4	IPX4	IPX4
Exterior Grille	125mm Fixed Louvre	125mm Fixed Louvre	125mm Eggcrate	125mm Eggcrate	100mm Eggcrate	-
Duct	3m x 125mm	3m x 125mm	3m x 125mm	3m x 125mm	3m x 100mm	-

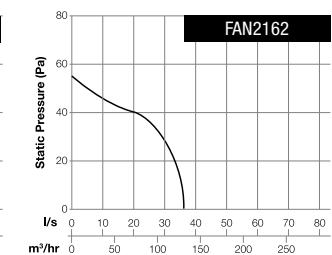
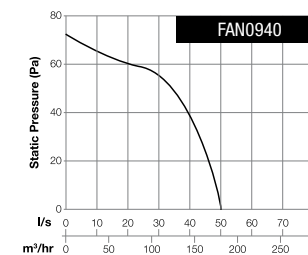
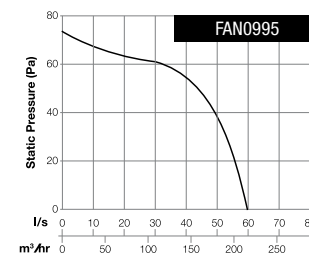

Manrose Heat-Fan-Light systems have been tested to the downlight standard AS/NZS60598.2.2 Amendment A and are all classified as CA135.



Through Roof Fan Cowl

High quality aluminium cowl construction with fan incorporated. 2 year warranty.

Through Roof Fan Cowl - Air Extraction

Classic	Tube (mm Ø)	Fan Type	Max. Fan Watts (W)	Max. Fan Pressure (Pa)	Free Air Fan Performance		Specific Fan Power (W/l/s)	Sound dB(A)	Switching	Product Code
					(l/s)	(m³/hr)				
	250	Centrifugal	75	300	178	640	0.42	72	Standard	FAN2120
		Centrifugal (High Performance)	135	545	265	954	0.51	70	Standard	FAN2121
	150	Centrifugal	70	320	153	550	0.46	62	Standard	FAN0529
		Centrifugal (3-Speed)	70	320	153	550	0.46	62	Standard	FAN1002
		EC Axial	18	91	105	380	0.17	38	Standard	FAN1009 FAN0531

Through Roof Fan Cowl - Air Supply

Classic	Tube (mm Ø)	Fan Type	Max. Fan Watts (W)	Max. Fan Pressure (Pa)	Free Air Fan Performance		Specific Fan Power (W/l/s)	Sound dB(A)	Switching	Product Code
					(l/s)	(m³/hr)				
	150	EC Axial	18	91	105	380	0.17	38	Standard	FAN0533

Accessories

Model	Filter Ring	Insect Mesh
FAN2120 FAN2121	DCT2254	DCT2253

Through Roof Fan Cowl

Dimensions (mm)

Model	A	B	C
FAN2120 FAN2121	400	400	248
FAN0529 FAN0531 FAN0533 FAN1002 FAN1009	275	170	-

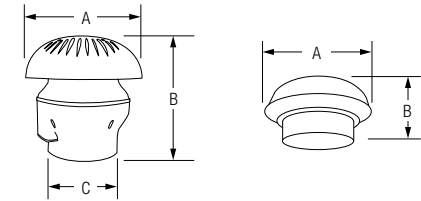

Technical

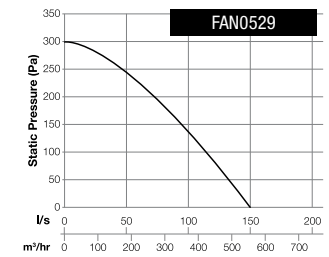
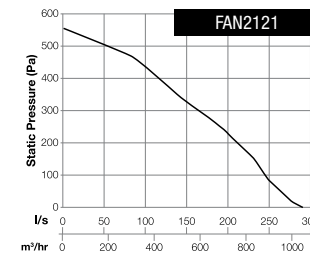
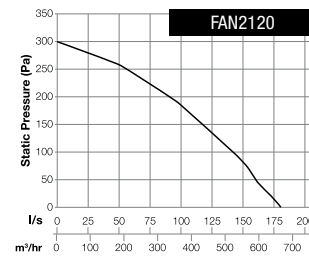

Model	FAN2120 FAN2121	FAN0529	FAN1002	FAN0531	FAN0533	FAN1009
Supply	220-240V AC, 50Hz					
Operating Temp	-25°C - 40°C		-25°C - 50°C		-20°C - 45°C	
IP Rating	IP44		IPX4		IP44	



Through Roof Fan Kits

High quality aluminium cowl construction with fan incorporated. 2 year warranty.

Through Roof Fan Cowls with Flashing & HDPE Tube - Air Extraction

Classic	Tube (mm Ø)	Fan Type	Max. Fan Watts (W)	Max. Fan Pressure (Pa)	Free Air Fan Performance		Specific Fan Power (W/l/s)	Sound dB(A)	Switching	Product Code
					(l/s)	(m³/hr)				
	250	Centrifugal	75	300	178	640	0.42	72	Standard	FAN2122
		Centrifugal (High Performance)	135	545	265	954	0.51	70	Standard	FAN2123
	150	Centrifugal	70	320	153	550	0.46	62	Standard	FAN0530
		Centrifugal (3-Speed)	70	320	153	550	0.46	62	Standard	FAN0967
		EC Axial	18	91	105	380	0.17	38	Standard	FAN1060 FAN0532

Through Roof Fan Heavy Duty Cowls with Flashing & HDPE Tube - Air Extraction

Classic	Tube (mm Ø)	Fan Type	Max. Fan Watts (W)	Max. Fan Pressure (Pa)	Free Air Fan Performance		Specific Fan Power (W/l/s)	Sound dB(A)	Switching	Product Code
					(l/s)	(m³/hr)				
	150	Centrifugal	70	320	153	550	0.46	62	Standard	FAN0740
		EC Axial	18	91	105	380	0.17	38	Standard	FAN0739

Through Roof Fan Cowls with Flashing & HDPE Tube - Air Supply

Classic	Tube (mm Ø)	Fan Type	Max. Fan Watts (W)	Max. Fan Pressure (Pa)	Free Air Fan Performance		Specific Fan Power (W/l/s)	Sound dB(A)	Switching	Product Code
					(l/s)	(m³/hr)				
	150	EC Axial	18	91	105	380	0.17	38	Standard	FAN0534

Through Roof Fans with Flashing for Metal Based Roof - Air Extraction

Classic	Tube (mm Ø)	Fan Type	Max. Fan Watts (W)	Max. Fan Pressure (Pa)	Free Air Fan Performance		Specific Fan Power (W/l/s)	Sound dB(A)	Switching	Product Code
					(l/s)	(m³/hr)				
	150	Centrifugal	70	320	153	550	0.46	62	Standard	FAN0535
	150	EC Axial	18	91	105	380	0.17	38	Standard	DCT0189

Accessories

Model	Cowl	Filter Ring	Insect Mesh
FAN2122 FAN2123	DCT2241	DCT2254	DCT2253

Through Roof Fan Kits

Dimensions (mm)

Model	A	B	C
FAN0530 FAN0532 FAN0534 FAN0739 FAN0740 FAN0967 FAN1060	275	170	500

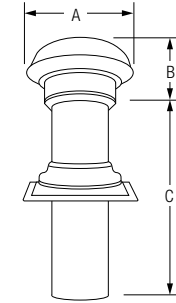

Technical

Model	FAN2121 FAN2123	FAN0530 FAN0740	FAN0967	FAN0532 FAN0739	FAN0534	FAN1060
Supply	220-240V AC, 50Hz					
Max. Operating Temp	-25°C - 60°C		-25°C - 50°C		-20°C - 45°C	
IP Rating	IP44		IPX4		IP44	

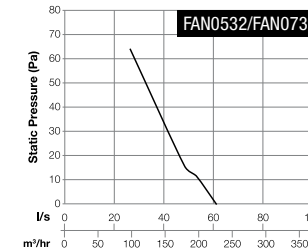
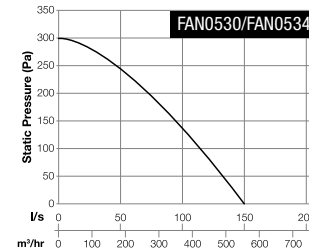
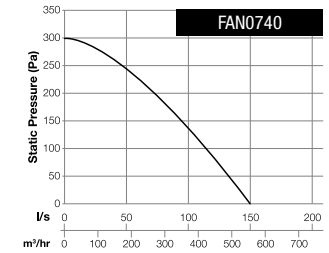
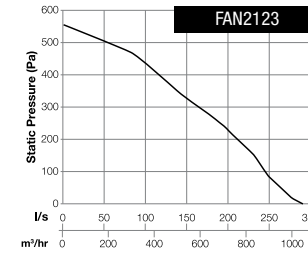
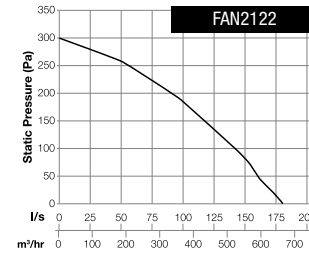

Roof Cowls

Roof Cowls

Classic	Tube (mm Ø)	Description	Product Code
	150	General Purpose	DCT0708
		Heavy Duty	DCT0709

- Added exhaust aperture area and deep vent coverage
- Recommended where high winds in exposed locations may drive rain into the vent
- Also recommended for use in high airflow air intake systems to prevent rain being sucked into the system

Dimensions (mm)

Description	A	B
General Purpose	275	125
Heavy Duty	275	140

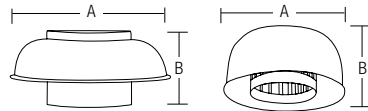

Technical - Pressure Loss

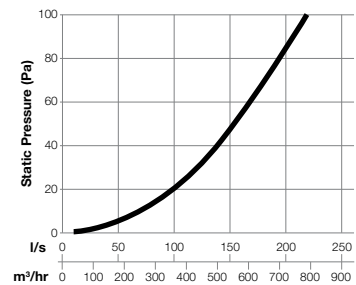

Roof Cowl Kits

Roof Cowl Kits

Classic	Tube (mm Ø)	Description	Product Code
	200	Medium Duty Kit with Aluminium Cowl and 0.5m Galvanised Tube	DCT3603
		Heavy Duty Kit with Aluminium Cowl and 0.5m Galvanised Tube	DCT3604
	150	General Purpose Kit with Aluminium Cowl and 0.5m HDPE Tube	DCT0172
		Heavy Duty Kit with Aluminium Cowl and 0.5m HDPE Tube	DCT0710
		General Purpose Kit with Aluminium Cowl, 0.5m HDPE Tube and Heavy Duty Lead Flashing	DCT1095
	150 to 125	Reducer	DCT2066
150 to 100	Reducer	DCT2122	

- Flashing, for metal based roofs, included and all fittings supplied (*refer to Roof Flashings below*)
- Optional lead flashing available (*refer to Roof Flashings below*)
- Reducers fit to the bottom of HDPE tube to adapt to smaller duct diameters where required
- 150mm general purpose kit suitable for moderately exposed sites. Synthetic rubber flashing, for metal based roofs, included along with screw fasteners and tube strap

Classic	Tube (mm Ø)	Description	Product Code
	125	Angled	DCT2205

- 0.5m PVC tube (110mm), suitable for smaller applications
- To be mounted on tile roofs only
- Weathering slate included

Through Roof Fan Accessories

Description	Product Code
Roof flashing - fits 110-160mm	DCT0180
Roof flashing for use on concrete tile, clay tile and slate roofing	DCT0190
0.5m x 150mm HDPE tube	DCT0183
Stitching screws for roof flashing	FAN0400



MultiVent

Continuous Extract Ventilation
from **Vent-Axia**.

Complies with
**New Zealand Green Building Council
Homestar v5 - Level 6 to Level 8***

*An additional 1 point available for commissioning.



Improved Indoor Air Quality

Virus and pollutant extraction as part of improved IAQ. Continuous slowly refreshed air through market leading MultiVent continuous extract ventilation system.



Continuous Extract with Automated Humidity Control

The air quality benefits of continuous "trickle" extract ventilation with automated boost speeds when needed via continuous humidity sensing and control.



Ultra Quiet & Energy Efficient Performance

The MultiVent continuous extract ventilation system has been carefully designed using cutting edge computational fluid dynamics airflow modelling to reduce energy loss and noise across all performance speeds.



MultiVent Continuous Extract Ventilation System

The MultiVent continuous extract ventilation system is a centralised fan unit mounted in your roof cavity or cupboard that draws stale moist air and odours from your bathroom, laundry and toilet, delivers better indoor air quality. The extracted air is replaced through natural air flow through the gaps around doors and windows, trickle inlet slots, or the Manrose Puro Filtered Passive Vent Kit (DCT4565).

This slow continuous flow with humidity sensed boost automation from the Vent-Axia MultiVent unit ensures refreshed indoor air quality by extracting pollutants including volatile organic compounds, bacteria and viruses - as recommended by health authorities including WHO. 7 year warranty.

MultiVent	Duct (mm)	Fan Type	Max Fan Watts (W)	Max Fan Pressure (Pa)	Free Air Fan Performance		Minimum Specific Fan Power (W/l/s)	Sound dB(A)	Order Code
					(l/s)	(m³/hr)			
	125mm /150mm	Centrifugal	85	810	159	572	0.14	52	FAN7200 (Ventilation Kit)
									FAN7453 (Single Unit)

- Continuous "trickle" extract ventilation from three rooms
- Automated boost speeds activated via humidity sensing and control
- Four speed centrifugal fan
- 123 l/s (443 m³/hr) at 200 Pa
- Market leading lo-carbon energy efficiency
- On-board digital controls for speedy installation
- Proportional humidity sensor
- Compact design
- Manufactured in the UK from recycled materials

Dimensions (mm)

Ceiling Extract Cut-Out Size	A	B	C	D	E	ØF
123mm	330	390	111	250	96	125

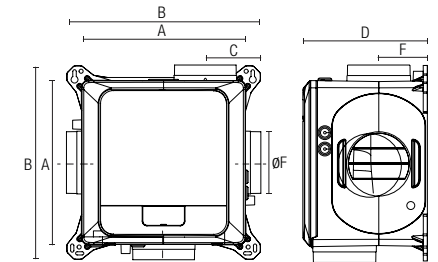

Technical

Supply	220-240V AC, 50Hz
Max. Operating Temp	40°C
IP Rating	IPX2
Motor Housing	Die Cast Aluminium
Impeller & Outer Rotor	PBT Plastic
Weatherproof Cowl	150mm Stainless Steel
Ducting	Aluminium Foil

Contents

- 1x MultiVent Base Unit
- 1x 150mm Weatherproof Cowl - Stainless Steel
- 3x 125mm x 6m Aluminium Foil Flexible Duct
- 1x 150mm x 6m Aluminium Foil Flexible Duct
- 3x 125mm Cone Adjustable Mainflow Ceiling Extract Diffuser
- 1x 150mm to 125mm Reducer and Joiner
- 1x 30m x 48mm PVC Duct Tape

Performance Guide – variable speed range

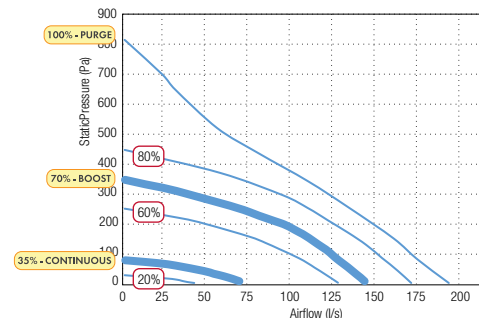

Inline Centrifugal Extract Fans

These K fans are designed for installation in ducts. All the K fans have a minimum 25mm long spigot connections. The fans have backward-curved blades and external rotor motors 2 year warranty.

Alaskon K	Fan Speed (RPM)	230V/50Hz/1 Φ		Sound dB(A)	Free Air Fan Performance		Capacitor (μ F)	K Model	Order Code
		Motor Input (kW)	Full Load Current (A)		(l/s)	(m ³ /s)			
	2560	0.108	0.47	43	210	0.21	3	150L	FAN5452
	2560	0.112	0.50	43	235	0.24	3	200M	FAN5454
	2500	0.165	0.71	45	285	0.29	3.5	200L	FAN5453
	2640	0.111	0.50	47	240	0.24	3.5	250L	FAN5455
	2550	0.269	1.18	48	425	0.43	7	315L	FAN5457



- High efficiency backward curve motorised impeller
- Full metal construction
- Suitable for outside applications
- Speed-controllable
- Sealed for life ball bearings

Inline Centrifugal Extract Fans

Dimensions (mm)

Model	Dimensions				Weight (kg)
	\emptyset d	\emptyset d	A	B	
150L	159	345	30	170	3.9
200M	199	245	35	228	4.1
200L	199	345	32	160	4.7
250L	249	345	30	163	4.0
315L	314	402	32	185	6.0

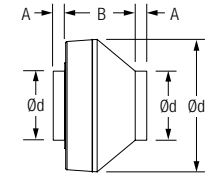

Technical

K Model	150L	200M	200L	250L	315L
Supply	220-240V AC, 50Hz				
Max. Operating Temp	70°C				
IP Rating	IP44				



Roof Mounted Axial Extract Fans - Side Discharge

These fans are designed for general purpose applications. They are suitable for air extraction situations where air volumes are moderate and pressures are low. The motorised impellers are efficient, smooth running and have excellent low sound characteristics. Speed can be controlled by electronic or autotransformer voltage regulation. Cowl material is UV-stabilised Rovol polymer or polyethylene. 2 year warranty.

Alaskon BRA	Fan Speed (RPM)	230V/50Hz/1Φ		Sound dB(A)	Induct Sound Power Level (dB re 10 ⁻¹² Watts)								Model	Order Code
		Motor Input (kW)	Full Load Current (A)		63	125	250	500	1k	2k	4k	8k		
					63	125	250	500	1k	2k	4k	8k		
	1390	69	0.53	40	62	59	61	60	58	56	54	43	BRA2541	FAN3751
	1250	75	0.32	38	66	64	59	55	52	50	46	38	BRA3041	FAN3753
	1340	165	0.73	42	76	68	61	57	57	55	52	46	BRA3541	FAN3759
	1430	160	0.73	49	76	72	66	65	65	61	57	52	BRA4041	FAN3762
	1310	490	2.36	48	75	68	64	63	63	63	59	57	BRA4541	FAN3769
	1300	680	3.0	47	77	72	63	61	61	60	58	52	BRA5041	FAN3774
	895	410	1.8	46	68	75	61	62	64	58	51	49	BRA5661	FAN3780
	860	600	2.62	46	71	68	63	64	62	58	52	52	BRA6361	FAN3786



- External rotor motorised impeller
- Sickle shaped low sound impeller
- UV-stabilised Rovol polymer or polyethylene cowl
- Speed controllable
- Sealed for life ball bearings

Dimensions (mm)

Model	Size (mm)	Dimensions					Weight (kg)
		A*	B*	C	D	E	
BRA2541	250	400	300	480	253	50	8
BRA3041	300	460	360	600	259	50	14
BRA3541	350	530	430	710	355	50	18
BRA4041	400	580	480	710	355	50	18
BRA4541	450	630	530	844	390	50	31
BRA5041	500	660	560	970	435	50	36
BRA5661	560	730	630	1150	470	50	41
BRA6361	630	810	750	1150	470	50	43

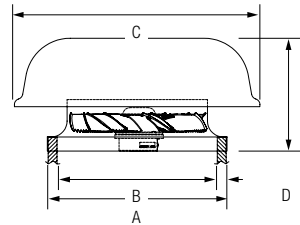

* Upstand construction details

Technical

Model	BRA2541	BRA3041	BRA3541	BRA4041	BRA4541	BRA5041	BRA5661	BRA6361
Poles	4	4	4	4	4	4	6	6
Supply	220-240V AC, 50Hz							
Max. Operating Temp	50°C	50°C	60°C	40°C	60°C	60°C	60°C	60°C
IP Rating	IP54							

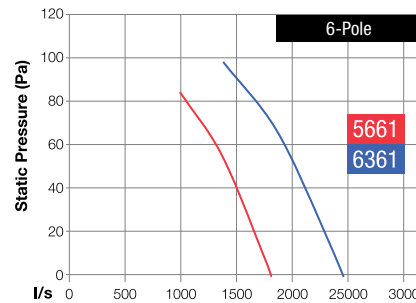
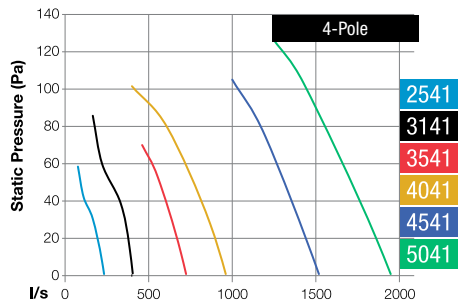

Plate Mounted Axial Extract Fans

These fans are for general purpose applications. They are suitable for air extraction situations where air volumes are moderate and pressures are low. The motorised impellers are efficient, smooth running and have excellent low sound characteristics. Standard airflow in Form A. Speed can be controlled by electronic or autotransformer voltage regulation.

Alaskon BAP	Fan Speed (RPM)	230V/50Hz/1Φ		Sound dB(A)	Induct Sound Power Level (dB re 10 ⁻¹² Watts)								Model	Order Code
		Motor Input (kW)	Full Load Current (A)		63	125	250	500	1k	2k	4k	8k		
					63	125	250	500	1k	2k	4k	8k		
	1390	69	0.53	40	62	59	61	60	58	56	54	43	BAP2541	FAN5334
	1250	75	0.32	38	66	64	59	55	52	50	46	38	BAP3041	FAN5335
	1340	165	0.73	42	76	68	61	57	57	55	52	46	BAP3541	FAN5336
	1430	160	0.73	49	76	72	66	65	65	61	57	52	BAP4041	FAN5337
	1310	490	2.36	48	75	68	64	63	63	63	59	57	BAP4541	FAN5338
	1300	680	3	47	77	72	63	61	61	60	58	52	BAP5041	FAN5339
	895	410	1.8	46	68	75	61	62	64	58	51	49	BAP5661	FAN5340
	860	600	2.62	46	71	68	63	64	62	58	52	52	BAP6361	FAN5341



- External rotor motorised impeller
- Sickle shaped low sound impeller
- Speed controllable
- Sealed for life ball bearings
- Integral inlet wireguard

Dimensions (mm)

Model	Dimensions					Weight (kg)
	A	B	C	D	E	
BAP2541	370	320	250	260	90	4
BAP3041	430	380	305	325	90	5
BAP3541	485	435	350	360	90	6
BAP4041	540	490	400	410	110	9
BAP4541	575	535	450	460	110	10
BAP5041	655	615	500	510	115	14
BAP5661	725	670	560	575	115	16
BAP6361	805	750	630	645	125	21

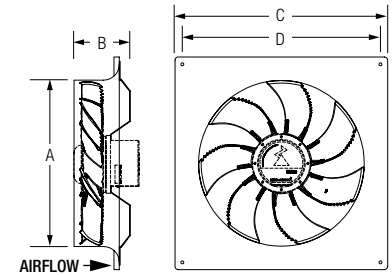

Technical

Model	BAP2541	BAP3041	BAP3541	BAP4041	BAP4541	BAP5041	BAP5661	BAP6361
Supply	220-240V AC, 50Hz							
Max. Operating Temp	50°C		60°C		40°C		60°C	
IP Rating	IP44							

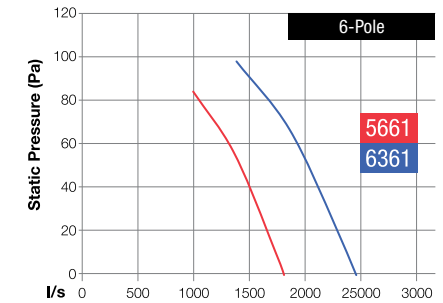
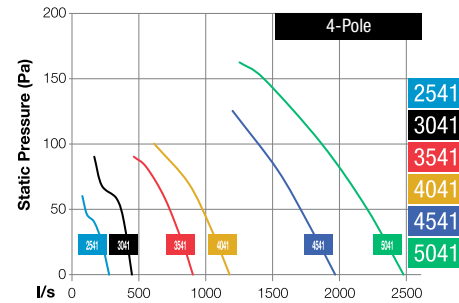

Frame Fans

Those frame fans are designed for use in computer rooms or applications where the introduction of cool air is required for small enclosed spaces. 2 year warranty.

Classic	Duct (mm)	Fan Type	Max. Fan Watts (W)	Max. Fan Pressure (Pa)	Free Air Fan Performance		Specific Fan Power (W/l/s)	Sound dB(A)	Switching	Model	Order Code
					(l/s)	(m³/hr)					
	150	Axial	18	91	105	380	0.17	38	Standard	FF150	FAN1043
	120	Axial	15	87	47	170	0.31	47	Standard	A12038V2	FAN0397

Accessory

Model	Finger Guard
FF150	FAN0841
A12038V2	FAN0412 - Metal
A12038V2	FAN0413



Dimensions (mm)

Model	A	B	C	D
FF150	51	150	172	160
A12038V2	40	120	160	105

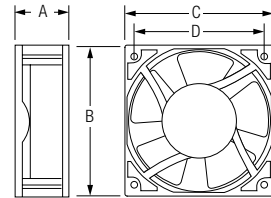

Technical

Model	FF150	A12038V2
Supply	220-240V AC, 50Hz	
Max. Operating Temp	70°C	80°C
IP Rating	IPX2	IPX4

Filtered Fresh Air Supply

Puro Filtered Passive Vent Kit	DCT4565
--------------------------------	---------



Ducting

Aluminium Flexible Duct x 3m

150mm	DCT0330
125mm	DCT0329
100mm	DCT0328



Acoustic Duct x 3m

150mm	DCT0633
-------	---------



PVC Flexible Duct

150mm x 3m	DCT0338
125mm x 4m	DCT0337
100mm x 5m	DCT0336



Semi-Rigid Duct x 3m

150mm	DCT0116
125mm	DCT0115
100mm	DCT0114



Duct Accessories

Inline Backdraught Shutters

150mm PVC	DCT0511
125mm PVC	DCT0036
100mm PVC	FAN0213



Duct Joiners

150mm Metal	DCT0059
125mm Metal	DCT0037
100mm PVC	DCT0159



Door Grille

Door Grille	FAN0159
-------------	---------



Duct Connectors

Cable Ties - 150mm	FAN0282
Cable Ties - 125mm	FAN0281
Cable Ties - 100mm	FAN0274
Duct Tape - 48mm x 5m	DCT0173
Duct Tape - 48mm x 30m	DCT0807



Interior Grilles/Soffit Grilles

Low Profile Grilles - Round Plastic

150mm - Matte Black	DCT4401
150mm - Gloss White	DCT1067
125mm - Gloss White	DCT1090
100mm - Gloss White	DCT1089



Interior Grilles/Soffit Grilles

Low Profile Grilles - Square Plastic

150mm - Matte Black	DCT4259
150mm - Gloss Black	DCT4314
150mm - Gloss White	DCT2225
125mm - Gloss White	DCT2224
100mm - Gloss White	DCT2223



Interior Grilles/Soffit Grilles

Standard Profile Grilles - Round Plastic

150mm - Matte Black	DCT4257
150mm - Gloss Black	DCT4315



Flat Face Grilles - Square Plastic

150mm - Matte Black	DCT4371
---------------------	---------



Eggcrate Grilles - White Plastic

150mm	DCT0473
125mm	DCT0472
100mm	DCT0375



Exterior Grilles

Weatherproof Cowls

(includes flap and bird mesh)

150mm - Matte Black Plastic	DCT4261
125mm - Matte Black Plastic	DCT4399
100mm - Matte Black Plastic	DCT4400
150mm - Gloss Black Plastic	DCT4316
150mm - Gloss White Plastic	DCT1031
125mm - Gloss White Plastic	DCT1030
100mm - Gloss White Plastic	DCT0018
150mm - Stainless Steel	DCT3616
125mm - Stainless Steel	DCT3615
100mm - Stainless Steel	DCT3614



Gravity Shutter Grilles

150mm - Black Plastic	DCT4320
150mm - White Plastic	DCT0066
125mm - White Plastic	DCT0044
100mm - White Plastic	DCT0029
150mm - Stainless Steel	DCT2147
125mm - Stainless Steel	DCT2146
100mm - Stainless Steel	DCT2145



Fixed Louvre Grilles - Square Plastic

150mm - Matte Black	DCT4373
125mm - Matte Black	DCT4429
100mm - Matte Black	DCT4428
150mm - Gloss Black	DCT4319
150mm - Gloss White	DCT0063
125mm - Gloss White	DCT0041
100mm - Gloss White	DCT0025



Accessories

Extraction Grilles

Extraction Grilles - Round Plastic

150mm - Gloss White	DCT2187
125mm - Gloss White	DCT2186
100mm - Gloss White	DCT2185



Roof Cowl Kits

General Purpose with Flashing & HDPE Tube

150mm	DCT0172
-------	---------

General Purpose with Lead Flashing & HDPE Tube

150mm	DCT1095
-------	---------

Heavy Duty with Flashing & HDPE Tube

150mm	DCT0710
-------	---------



Fan Timers

Timer - Fixed Run On Time (approx), AC only

Fan On Time	Run On Time	Code
up to 5 mins	7 mins	FAN0372
over 5 mins	12 mins	



Timer - Adjustable Run On Time
& Start Delay, AC/EC

Fan On Time	Run On Time	Code
up to 5 mins	up to 20 mins	FAN2444



Transformers

Electronic Transformer 12V AC, 50KHz

Transformer	FAN2101
-------------	---------



SELV Isolating Transformer 12V AC

Transformer	FAN0436
-------------	---------



Thermostats

Electronic Temperature Sensor Thermostats

Touch Screen Automated	FAN7194
Mechanical	FAN5856



Humidistat Controller

Dry and Damp Control Settings

15-200W Switching Capacity	FAN6085
----------------------------	---------



Speed Controllers

For XF/XP/WF 230/300 Fans*

2 Speed + Reverse	FAN0155
Adjust Speed + Reverse	FAN0156

* Load must be between 20-200W



General Purpose up to 500W

ON-OFF + Adjustable	FAN2104
---------------------	---------

Fan Mounting Brackets

Centrifugal Fan Mounting Bracket Pairs

Duct Size: 100-200mm	FAN0015
Duct Size: 250-315mm	FAN0016



Replacement Lamps

LED MR16

230V AC Silver GU10 4.5W	LHT0211
12V DC Silver GX5.3 3W	LHT0221
R80 Frosted 8W	LHT0979
Integrated 10W Silver Rim	LHT1085
Integrated 10W White Rim	LHT1047
Integrated 10W No Rim	LHT1107



Infrared Heat Lamps

R125 ES 275W	LHT0081
214mm Linear R7S 1000W	LHT0326

