



**Panasonic**  
AIR CONDITIONING



# Whole Home Solutions

Ducted & Multi Room Air Conditioning

2023/24

QUALITY AIR FOR LIFE



# Control Solutions

Easy-to-use, with multiple energy saving functions at your fingertips.

Available on Ducted and Mini VRF options, not available on Multi Systems.



**CONEX**

(CZ-RTC6 / CZ-RTC6BL / CZ-RTC6BLW)

## Simple and sophisticated design in-and-out

User friendly interface with stylish design measuring just 86 x 86 mm, CONEX is an extremely compact remote controller which looks great in any room.

## Easy control and access for end users, installers, and service partners with just one remote

User-friendly day-to-day operation for end users, simplified set up for installers, and convenient after-sales service access for service partners - all with one remote control.



## Deluxe Wired Remote Controller



### Large 3.5" full-dot LCD with white LED backlight

Characters and icons are clearly displayed for perfect visibility. With the white LED backlight, you can now change the temperature during the night without even turning on the light.

### Stylish, easy-to-use touch key design

The elegant, flat design features large touch keys in a simple layout enabling easy, intuitive operation.

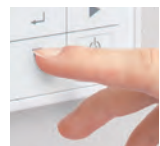

CONEX/CONEX Zone Controller



**Individual Comfort and Energy Saving**  
Airflow Volume Control

The damper opening can be controlled with the CFC app. Adjust the air volume conveniently according to your daily life.



**Auto-optimised Comfort for Your Lifestyle**  
Weekly timer

Able to set 6 timers/day. Realise optimal control day & night for your lifestyle with timers.

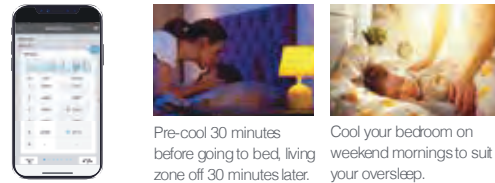

**Purifies Your Room with nanoe™ X**  
24hr Clean air

When you go out, clean the air with the nanoe™ mode. Pre-cool the living zone according to the time you return home.

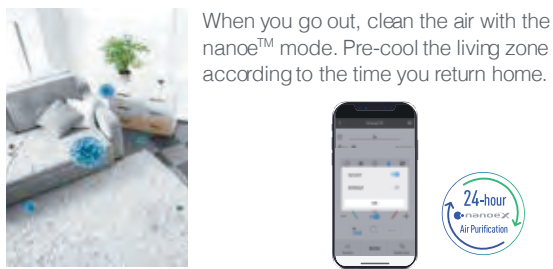

**Zone Status**

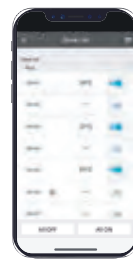

**Statistics**



**Other Hardware Requirements\***

Router - Internet - Smartphone  
(Required 2.4GHz transmission channel)  
\*Purchase and subscribe separately

**Compatible Device and Browsers**

1. iOS 9.0 or above
2. Android™ 5.0 Lollipop or later



**Download Free App**

Panasonic Comfort Cloud app

Note: Product images not to scale.

# Manage Up to 8 Zones with an Advanced Zone Control System

CONEX  
Zone Controller



Product movie



Ducted Air Conditioner



## Intuitive Control with Comfort Cloud App

Each family member can control home AC from multiple devices



Compatible Device and Browsers.  
• iOS 9.0 or above • Android™ 5.0 or above\*



## Zone controller CZ-RTC6Z

Thanks to built-in WLAN RC, set up is easy

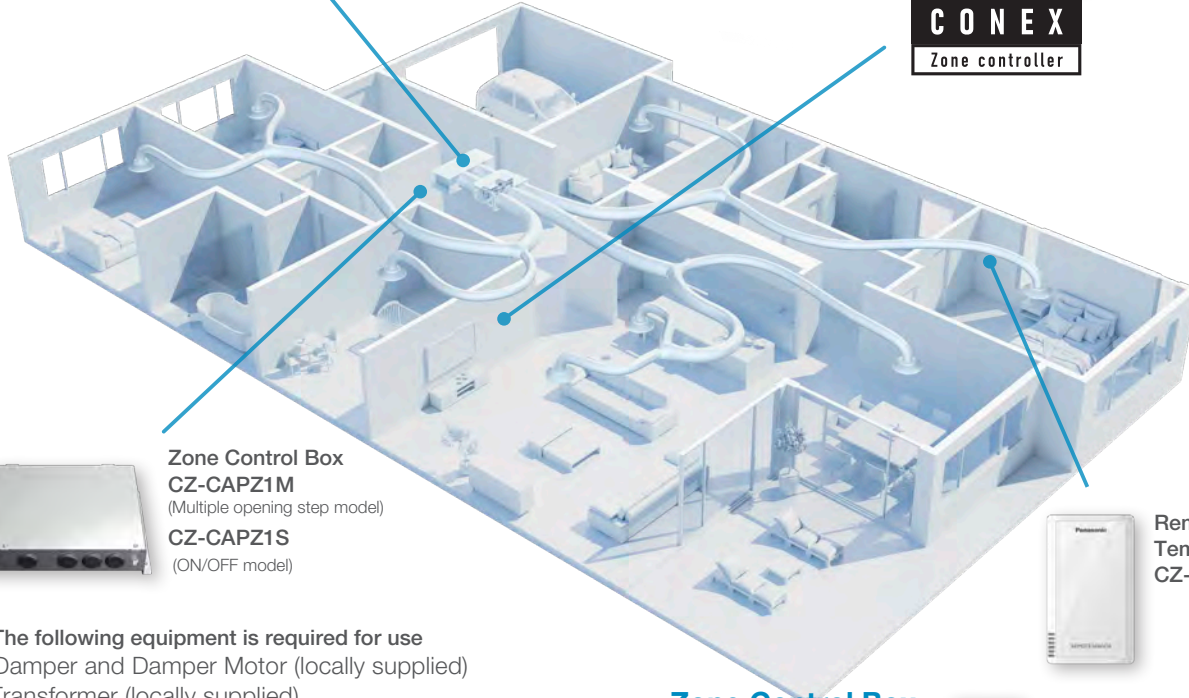

Zone Control Box  
CZ-CAPZ1M (Multiple opening step model)  
CZ-CAPZ1S (ON/OFF model)



Remote Temperature Sensor CZ-CSRC3 (optional)

- The following equipment is required for use  
Damper and Damper Motor (locally supplied)  
/Transformer (locally supplied)

## Zone Remote Controller



### Spec & dimensions

Model No.	CZ-RTC6Z
Dimensions	(H) 86 mm x (W) 86 mm x (D) 25 mm
Weight	0.10 kg
Temperature / Humidity range	0°C to 40°C / 20% to 80% (No condensation) • Indoor use only.
Power Source	DC16 V (supplied from indoor unit)
Wireless LAN standard	IEEE 802.11 b/g/n
Frequency range	2.4 GHz band
Encryption	WPA2-PSK (TKIP/AES)
OS version on the mobile device for CFC	iOS: 9.0 or later Android™: 5.0 or later

## Zone Control Box

### Spec & dimensions



Model No.	CZ-CAPZ1S/CZ-CAPZ1M
Dimensions	(H) 250 mm x (W) 342 mm x (D)70 mm
Weight	1.9 kg

## Remote Temperature Sensor

### Spec & dimensions



Model No.	CZ-CSRC3
Dimensions	(H) 120mm X (W) 70mm X (D) 17mm
Weight	70g
Temperature/Humidity range	0°C to 40°C / 20% to 80% (No condensation) Indoor use only.

## Usable indoor units

Zone Controller can be connected with 3.6 kW to 22.4 kW Ducted (PE3 and PF3) Indoors and VRF Ducted units (M1, E1, E2, E1R, F2, F3 and Z1).

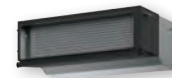

\*Connectable to selected Panasonic ducted models only, please consult Panasonic for more details.

Series	PE3	PF3	MM1	ME1	ME2	ME1R	MF2	MF3	MZ1
Capacity	6.0 kW-22.4 kW	3.6 kW-14.0 kW	2.2 kW-5.6 kW	7.3 kW-14.0 kW	18.0 kW-28.0 kW	9.0 kW-16.0 kW	2.2 kW-16.0 kW		2.2 kW-7.3 kW

Note: Product images not to scale.

\* iOS is the name of the OS of Apple Inc. iOS is a trademark or registered trademark of Cisco in the US and other countries where it is licensed for use.

Apple and the Apple logo are trademarks of Apple Inc. that are registered in the US and other countries. App Store is a service mark of Apple Inc.

\* Android™, Google Play™ and Google Play™ logos are registered trademarks of Google LLC.

## Panasonic Comfort Cloud features

### Voice Control

Control air conditioning units by voice command intuitively connecting to smart speaker.\*



### Multiple User

The Panasonic Comfort Cloud App allows multiuser access control. Restrict user access to specific units.



### From 1 to 200 units

User can control up to 200 indoor units. 10 different sites, with up to 20 units / groups per site.



### Energy Monitor

See the estimated power consumption and compare with other periods to see how energy bill can be reduced even more.\*\*

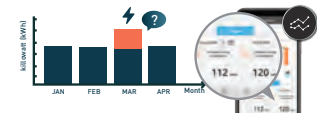

### Easy Scheduling

Complex weekly scheduling made simple. Not only for one units, but across multiple sites and from a smartphone.



### Error Codes

Error code notification through the App, provides early notification and allows for faster repair.



## Application Examples



Centralised control from reception.



Multiple location control for small business.

## System configuration

### Network Adaptor

CZ-TACG1 CZ-CAPWFC1



### Connection Diagram



Indoor Unit

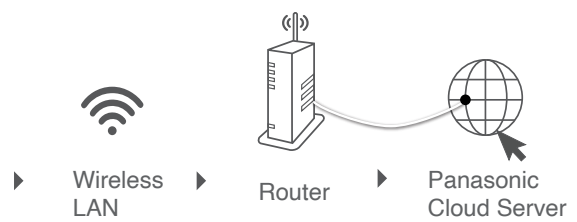

In conformity with IEEE 802.11

CZ-TACG1: For products for small sized project. (Page 40-41)  
 CZ-CAPWFC1: Available for all types of VRF and PAC indoor unit.

## WLAN Smart Adaptor specification

	CZ-TACG1	CZ-CAPWFC1
Input Voltage	DC 1.2V (Supplied from indoor unit)	
Power Consumption	Maximum 0.66W	Maximum 2.4W
Size [H x W x D]	66 x 36 x 12mm	120 x 70 x 25mm
Weight	Approx. 85g	190g (including communications lines)
Interface	Wireless LAN	
Wireless LAN Standard	IEEE 802.11 b/g/n	
Frequency range	2.4GHz band	
Encryption	WPA2-PSK(TKIP/AES)	
Operation range	0-55°C, 20 - 80RH%	



Comfort Cloud App



### Compatible Device and Browsers

1. IOS 9.0 or above
2. Android 4.4 or above

\*1 Time of release in Quarter Three 2019.  
 CZ-TACG1 or CZ-CAPWFC1 Network Adaptor required per unit.  
 Requires an Internet connection and the App downloaded from the App Store or GooglePlay Store on your smartphone or tablet with the latest Operating System available.  
 To use Amazon Alexa to control your air conditioner, you will need an Amazon Echo device.  
 To use Google Assistant to control your air conditioner, you will need a Google Assistant device.  
 Google is a trademark of Google LLC.  
 Amazon, Alexa and all related logos are trademarks of Amazon.com, Inc. or its affiliates.  
 \*\*2 Function available depending on the model.



## Ducted System

### Advantages

- Discrete and quiet
- Up to 8 rooms off one outdoor (up to 16kW)
- Range of different grill options
- Deluxe controller option
- Smart WiFi & Voice Control compatible

### Considerations

- Requires access space either in the ceiling or under the house
- Single set temperature for all rooms

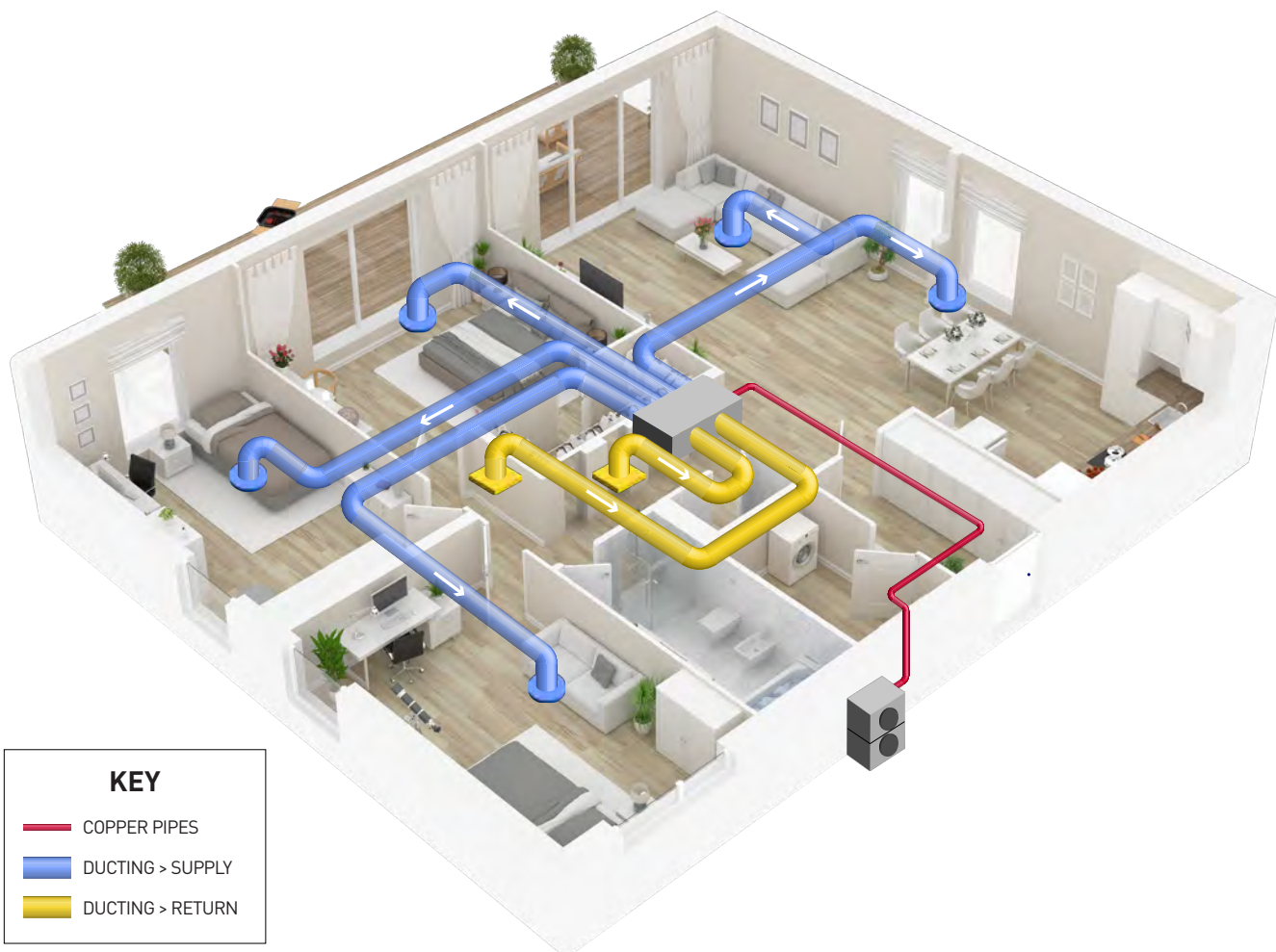



## Zone Control

Manage up to 8 Zones with an Advanced Zone Control System

### Advantages

- Individual comfort
- Airflow volume control
- Damper Position Control
- Weekly timer
- Target temperature control
- Track energy consumption
- On/Off nanoe™X
- Intuitive Control with Comfort Cloud App

### Considerations

- Automation temperature control is limited to sensing Zone (easily switchable to 4 independent sensors or unit return), note sensors are additional cost.

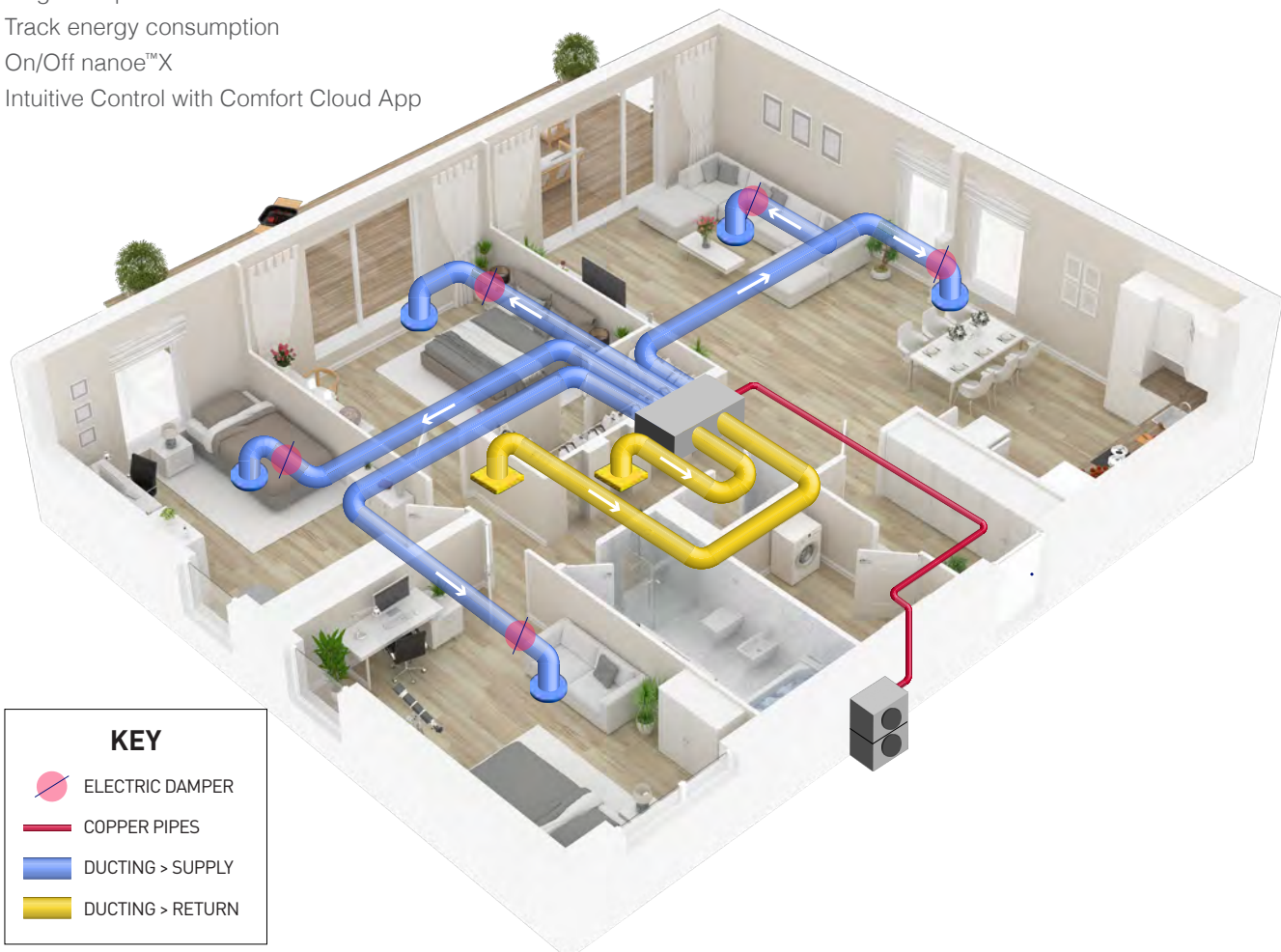



## Multi System

### Advantages

- Multiple indoor types
- Up to 5 rooms off one outdoor (up to 10kW)
- Individual control of each indoor unit
- Adjustable room temperatures
- Can be installed in most ceilings
- Smaller pipes so less space required in ceiling or underfloor cavity for installation
- Smart WiFi & Voice Control compatible

### Considerations

- Deluxe controller not available
- Choose between:
  - Aero – includes built in WiFi and nanoe™X or
  - Developer – standard unit

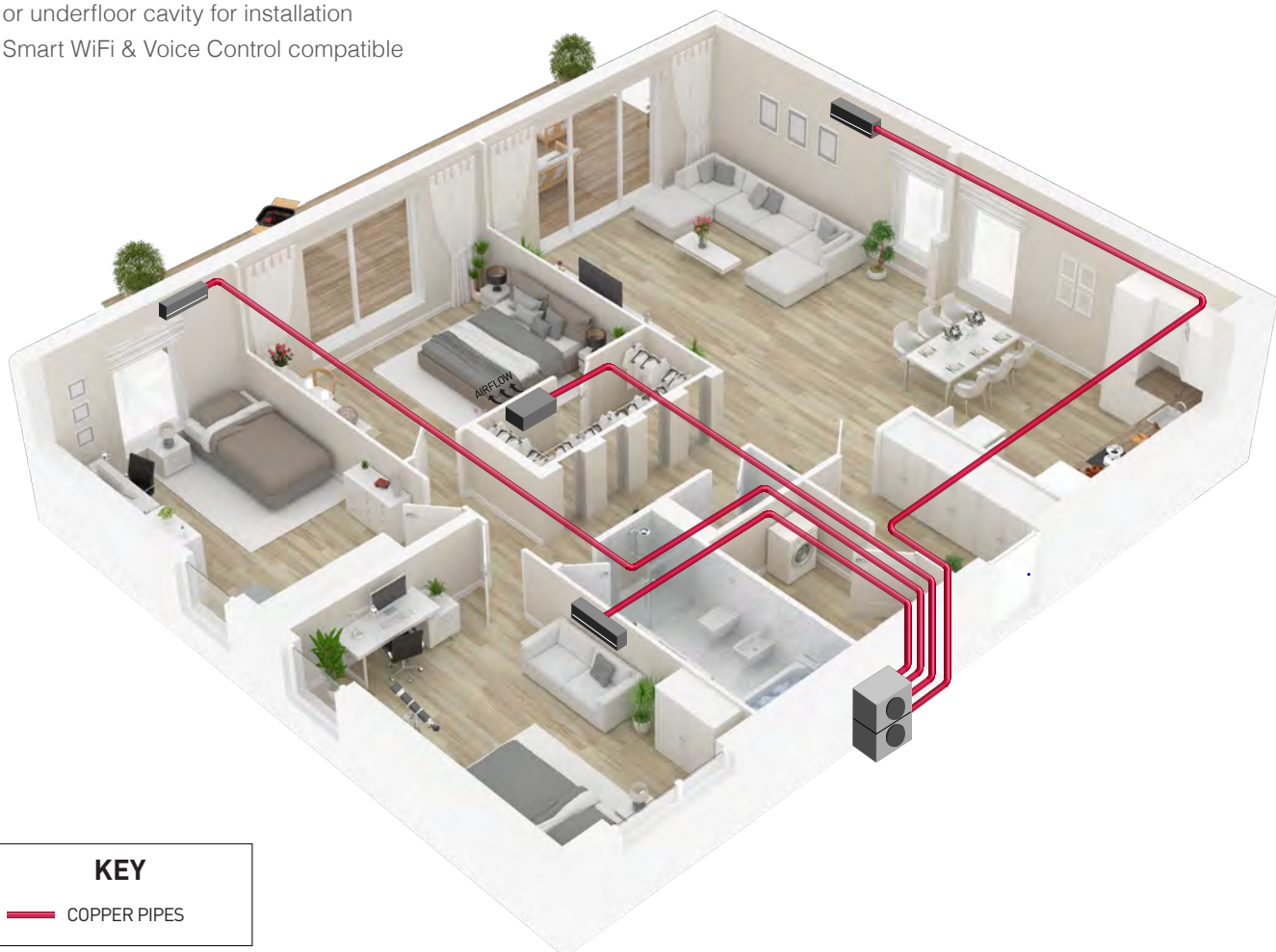





## Mini VRF System

### Advantages

- Multiple indoor types
- Up to 13 rooms off one outdoor (up to 28kW)
- Entire house off one outdoor
- Individual control of each indoor unit
- Long pipe lengths
- Adjustable room temperatures
- Suitable for larger homes
- Deluxe controller option
- Smaller pipes so less space required in ceiling or underfloor cavity for installation
- Smart WiFi & Voice Control compatible

### Considerations

- Higher cost
- Expert design required
- Larger units require 3 phase power

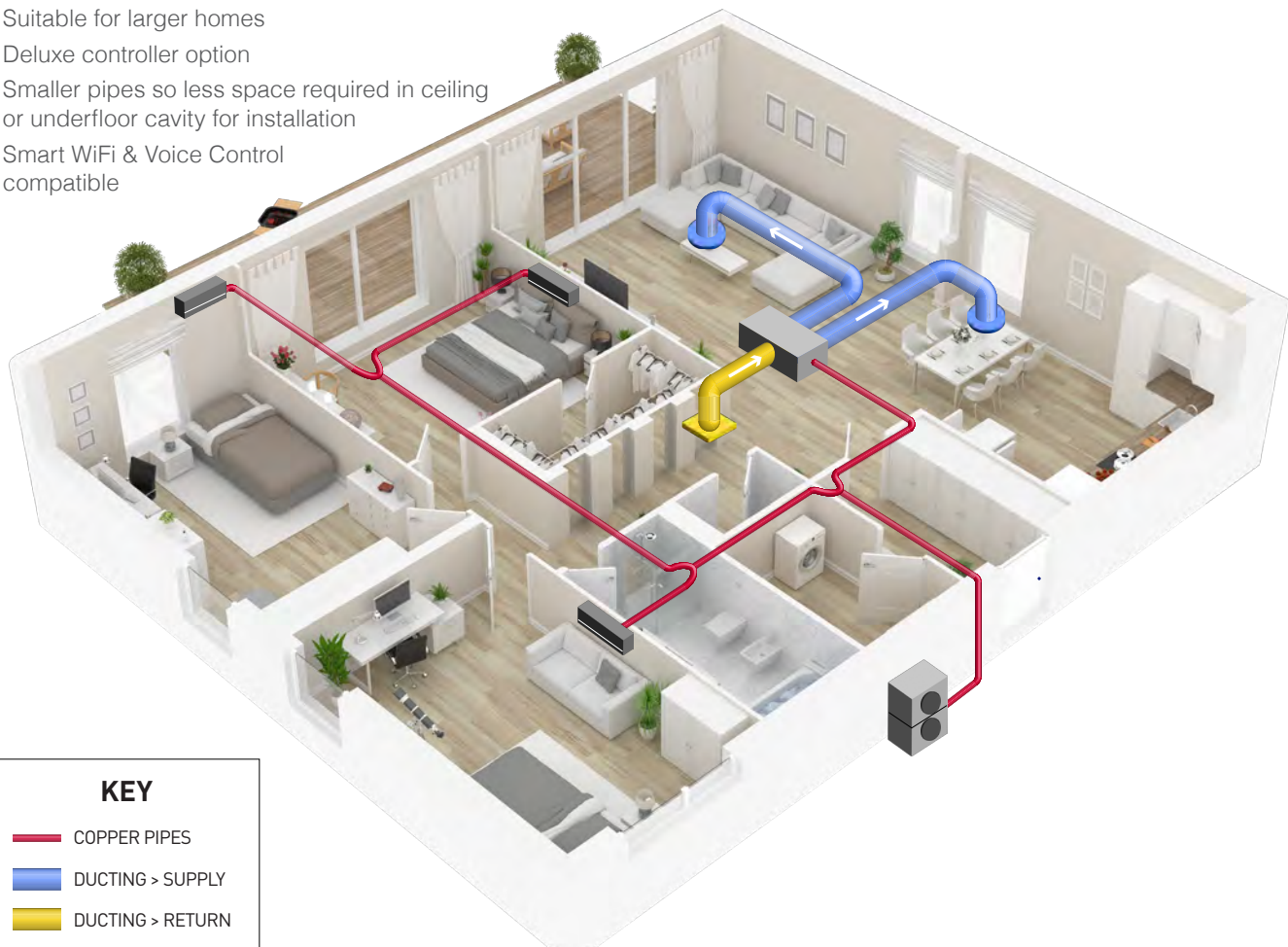

# All side discharge R32 outdoor units

Panasonic's new range of outdoor units feature intuitive technology and thoughtful engineering. The two innovative ranges of R32 units, both Deluxe and Compact, feature energy and space saving technologies, permitting installation in even the tightest and most demanding conditions.



## More Efficient, Less Space

Whilst maintaining its strong power, new R32 outdoor units get smaller. This enables them to fit into tighter spaces. Thus you can install these units in a vast variety of areas.

### All side discharge from 6.0kw to 22.4kW

R32 Deluxe



### Industry-leading Small Body with All 1-fan Models

R32 Compact



\*\* 3 phase

## Precise Temperature Control

### Constant Comfort Air Conditioning

R32 Deluxe

Another advantage of Panasonic Premium Inverter technology includes its ability to ensure precise temperature control and offer a wider power output range to perform in even the most extreme conditions in Australia, ensuring constant comfort.

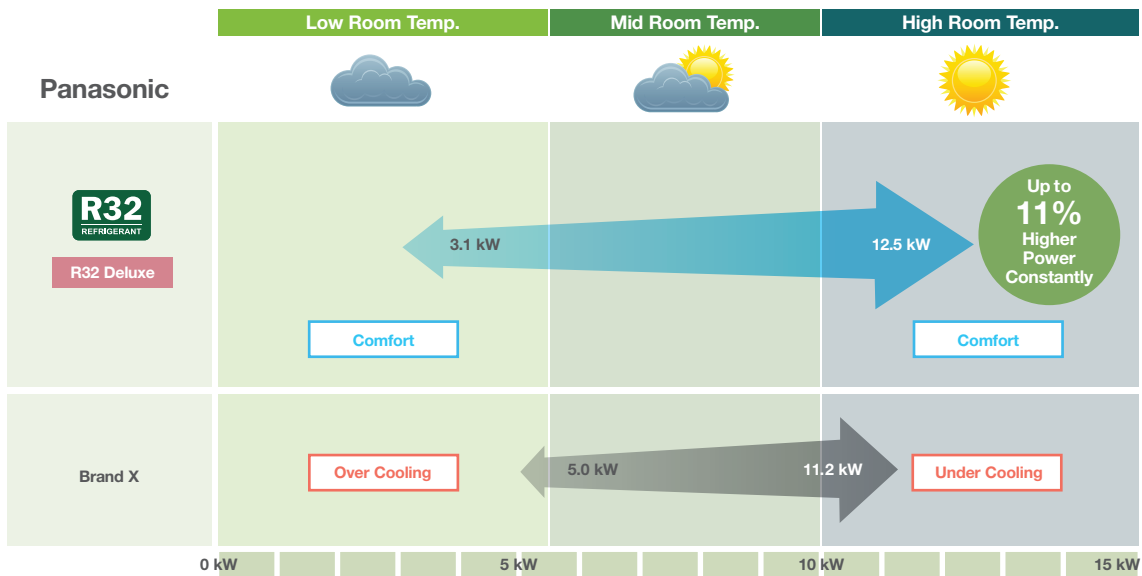

Graph shows each models' 10.0 kW Inverter High Static Pressure Ducted systems performance range during cooling.

## NX Series - Refurbishing Made Easy

The new NX series has been developed to use 3-wired communication, making it simple to replace the three wire systems often used in older installations.

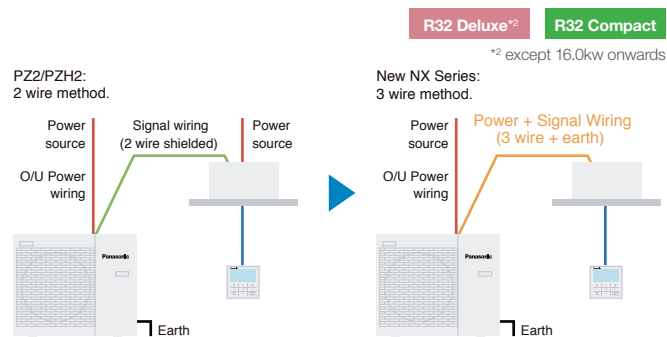

## R22 Renewal. Fast, easy to install and cost-effective

Panasonic refrigerant oil is engineered to avoid the damage to units that can happen when oil types commonly found in air-conditioning systems react with each other. As well as preventing damage, this makes replacing R22 systems with the latest R32 model as simple as reusing the existing piping and replacing the indoor and outdoor unit. Switching to the latest R32 system also improves energy efficiency by approximately 30% compared to the R22 system.

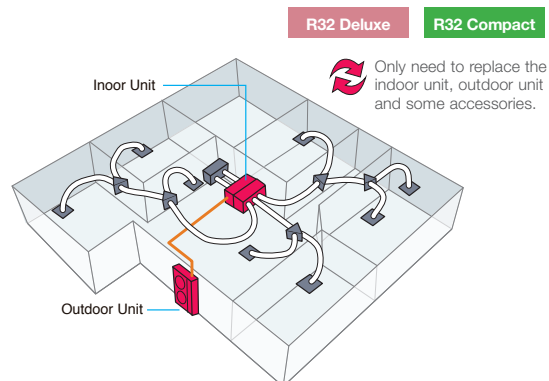

Note: Only use existing piping after checking "IN CASE OF REUSING EXISTING REFRIGERANT PIPING" in the installation manual.

# Indoor Unit High Static Pressure Ducted

High static and large airflow ducted for exceptional installation flexibility.

**nanoe<sup>TM</sup>X**  
nanoe<sup>TM</sup> X as a standard\*  
\*nanoe X Generator Mark 2

**ECONAVI**

ECONAVI ready

-   
Self-diagnosing  
Function
-   
Automatic  
Fan  
Operation
-   
Dry mode
-   
Automatic  
Restart  
Function
-   
DC Motor\*<sup>1</sup>  
\*1 only for 6.0-12.5kw

## Technical focus

- Design flexibility thanks to high static pressure and large air volume
- Accurate temperature control to reduce cold drafts during operation
- Configurable air temperature control

## Compact Body Size

Hidden in the ceiling, ideal when interior decor is an important consideration such as in residences with many rooms and light commercial buildings.

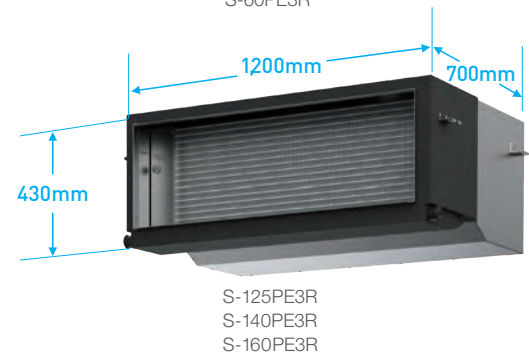

## System Example

An inspection port (450 mm x 450 mm or more) is required at the control-box side of the indoor unit body.

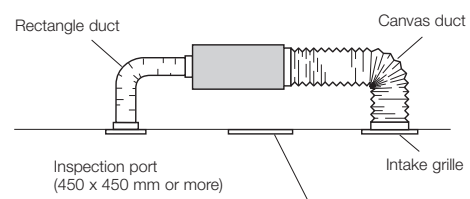

S-60PE3R



S-71PE3R  
S-100PE3R



S-125PE3R  
S-140PE3R  
S-160PE3R



CZ-RTC6  
CZ-RTC6BL  
CZ-RTC6BLW

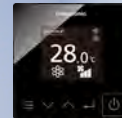

CZ-RTC6Z\*



CZ-RTC5B



CZ-RTC4



CZ-CAPWFC1



CZ-CENSC1

\*Zone Controller for residential use  
Note: Product image not to scale.

HSP Ducted



Product movie

## Clean air. Ducts that deliver

Testing has verified that even with three bends and a total length of up to 10m, the effectiveness of nanoe™ X is maintained right through the duct to deliver clean, fresh air where it's needed.

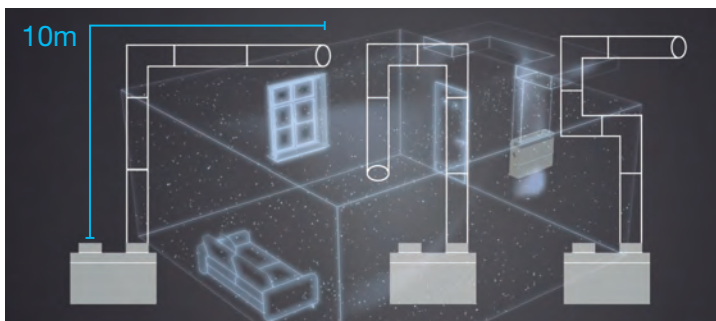

As the experiments demonstrate; even with a total ductwork length of up to 10m, effectiveness of nanoe™ X is maintained.

Note: PF3 and PE3 (16.0kW and below) ranges only.

## Cold Drafts Reduced During Heating Operation

- Accurate temperature measurement by E1/E2 sensor to reduce cold drafts during heating operation.

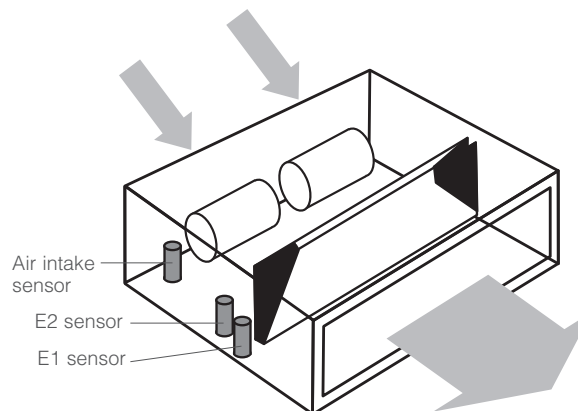

# Indoor Unit: High Static Pressure Ducted

## High Static Pressure Duct R32 Deluxe model



Capacity		7.1kW		10.0kW		12.5kW		
Model Name		S-71PE3R		S-100PE3R		S-125PE3R		
		Outdoor Unit		U-71PZH3R5		U-100PZH3R5		
Cooling capacity :	kW	7.1 (2.2 - 9.0)		10.0 (3.1 - 12.5)		10.0 (3.1 - 12.5)		
		8.0 (2.0 - 9.0)		11.2 (3.1 - 14.0)		14.0 (3.2 - 16.0)		
Heating capacity	BTU/h	24,200 (7,500 - 30,700)		34,100 (10,600 - 42,700)		34,100 (10,600 - 42,700)		
		27,300 (6,800 - 30,700)		38,200 (10,600 - 47,800)		47,800 (10,900 - 54,600)		
EER : COP	W/W	3.48 : 3.88		3.79 : 3.78		3.79 : 3.78		
COP@H2 condition	W/W	2.80		2.77		2.77		
Total power input	kW	2.04 : 2.06		2.64 : 2.96		2.64 : 2.96		
		4.68 : 4.82		5.04 : 5.10		5.04 : 5.10		
TCSPF : HSPF	Residential	Average Climate	4.11 : 4.22		4.46 : 4.34		4.46 : 4.34	
		Cold Climate	4.19 : 3.79		4.54 : 3.93		4.54 : 3.93	
		Hot Climate	5.15 : 4.85		5.55 : 5.15		5.55 : 5.15	
	Commercial	Average Climate	5.00 : 4.52		5.47 : 4.73		5.47 : 4.73	
		Cold Climate	5.37 : 4.11		5.87 : 4.32		5.87 : 4.32	
		Hot Climate	4.68 : 4.82		5.04 : 5.10		5.04 : 5.10	
Indoor Unit		Phase/Hz		1 Phase / 50Hz		1 Phase / 50Hz		
Power source		V		230V   240V		230V   240V		
Current (rated)		Cooling : Heating		— <sup>1</sup>		— <sup>1</sup>		
Dimension H x W x D		Indoor		360 X 1,200 X 700		360 X 1,200 X 700		
Net weight		Indoor		36		37		
Air volume (H/M/L)		Cooling : Heating		L/s		501 / 434 / 367 : 501 / 434 / 367		
External static pressure		Pa		100 (10 - 150)		100 (10 - 150)		
Sound pressure level (H/M/L)		Cooling : Heating		dB(A)		45 / 44 / 43 : 45 / 44 / 43		
Sound power level (H/M/L)		Cooling : Heating		dB		62 / 61 / 60 : 62 / 61 / 60		
Number of fan speeds				3		3		
Drain piping		mm		VP-25		VP-25		
Outdoor Unit		Phase/Hz		1 Phase / 50Hz		1 Phase / 50Hz		
Power source		V		230V   240V		230V   240V		
Current (rated)		Cooling : Heating		A		9.85 : 9.95   9.55 : 9.65		
Dimension H x W x D		mm		996 x 940 x 340		1,416 x 940 x 340		
Net weight		kg		66		99		
Air volume		Cooling : Heating		L/s		1,018 : 1,002		
Sound pressure level (Silent mode)		Cooling : Heating		dB(A)		48 (46) : 50 (48)		
Sound power level (Silent mode)		Cooling : Heating		dB		64 (62) : 66 (64)		
Piping connections		Liquid / Gas		mm		Ø9.52 / Ø15.88		
Pipe length range		min. - max.		m		5 - 50		
Elevation difference (OU located lower, OU located higher)		m		15, 30		15, 30		
Maximum chargeless length		m		30		30		
Refrigerant at shipping / Additional gas amount		g		R32 1,950 / 45 (g/m)		R32 3,050 / 45 (g/m)		
Operating range		Cooling : Heating		°C		-15 to 48 : -20 to 24		

## Specifications of R32 Compact Model



Capacity		6.0kW		7.1kW		10.0kW		
Model Name		S-60PE3R		S-71PE3R		S-100PE3R		
		Outdoor Unit		U-71PZ3R5		U-100PZ3R5		
Cooling capacity :	kW	6.0 (2.0 - 7.1)		7.1 (2.6 - 7.7)		10.0 (3.0 - 11.5)		
		6.0 (1.8 - 7.0)		7.1 (2.1 - 8.1)		10.0 (3.0 - 14.0)		
Heating capacity	BTU/h	20,500 (6,800 - 24,200)		24,200 (7,200 - 27,600)		34,100 (10,200 - 39,200)		
		20,500 (6,100 - 23,900)		24,200 (7,200 - 27,600)		34,100 (10,200 - 47,800)		
EER : COP	W/W	3.26 : 4.08		3.21 : 4.25		3.58 : 4.08		
COP@H2 condition	W/W	3.00		3.11		2.88		
Total power input	kW	1.84 : 1.47		2.21 : 1.67		2.79 : 2.45		
		3.98 : 3.95		3.96 : 4.05		4.64 : 3.95		
TCSPF : HSPF	Residential	Average Climate	3.56 : 3.88		3.59 : 4.00		4.17 : 3.81	
		Cold Climate	3.58 : 3.59		3.63 : 3.70		4.23 : 3.55	
		Hot Climate	4.25 : 3.83		4.22 : 3.91		4.99 : 3.90	
	Commercial	Average Climate	4.16 : 3.74		4.19 : 3.83		4.98 : 3.80	
		Cold Climate	4.38 : 3.58		4.41 : 3.67		5.28 : 3.61	
		Hot Climate	3.98 : 3.95		3.96 : 4.05		4.64 : 3.95	
Indoor Unit		Phase/Hz		1 Phase / 50Hz		1 Phase / 50Hz		
Power source		V		230V   240V		230V   240V		
Dimensions H x W x D		Indoor		290 x 1,200 x 700		360 x 1,200 x 700		
Net weight		Indoor / Panel		31		37		
Air volume (H/M/L)		Cooling : Heating		L/s		367 / 334 / 267 : 367 / 334 / 267		
External static pressure		Pa		70 (10 - 150)		100 (10 - 150)		
Sound pressure level (H/M/L)		Cooling : Heating		dB(A)		43 / 41 / 40 : 43 / 41 / 40		
Sound power level (H/M/L)		Cooling : Heating		dB		60 / 58 / 57 : 60 / 58 / 57		
Number of fan speeds				3		3		
Drain piping		mm		VP-25		VP-25		
Outdoor Unit		Phase/Hz		1 Phase / 50Hz		1 Phase / 50Hz		
Power source		V		230V   240V		230V   240V		
Current (rated)		Cooling : Heating		A		8.50 : 6.85   8.15 : 6.60		
Dimensions H x W x D		mm		695 x 875 x 320		996 x 980 x 370		
Net weight		kg		43		83		
Air volume		Cooling : Heating		L/s		701 : 701		
Sound pressure level (Silent mode)		Cooling : Heating		dB(A)		48 (46) : 49 (47)		
Sound power level (Silent mode)		Cooling : Heating		dB		66 (64) : 67 (65)		
Piping connections		Liquid / Gas		mm		Ø6.35 / Ø12.7 <sup>3</sup>		
Pipe length range		min. - max.		m		3 - 40		
Elevation difference (OU located lower, OU located higher)		m		15, 30		15, 30		
Maximum chargeless length		m		30		30		
Refrigerant at shipping, Additional gas amount		g		R32 1,130 / 15 (g/m)		R32 2,400 / 45 (g/m)		
Operating range		Cooling : Heating		°C		-10 to 46 : -15 to 24		

14.0kW		16.0kW	
S-125PE3R	S-140PE3R	S-140PE3R	S-160PE3R
U-125PZH3R8	U-140PZH3R5	U-140PZH3R8	U-160PZH2R5
12.5 (3.2 - 14.0) <b>14.0 (3.2 - 16.0)</b>	14.0 (3.3 - 16.0) <b>16.0 (3.3 - 18.0)</b>	14.0 (3.3 - 16.0) <b>16.0 (3.3 - 18.0)</b>	16.0 (5.5 - 18.0) <b>18.0 (5.5 - 20.0)</b>
42,700 (10,900 - 47,800) <b>47,800 (10,900 - 54,600)</b>	47,800 (11,300 - 54,600) <b>54,600 (11,300 - 61,400)</b>	47,800 (11,300 - 54,600) <b>54,600 (11,300 - 61,400)</b>	54,600 (18,800 - 61,400) <b>61,400 (18,800 - 68,200)</b>
3.57 : 3.80	3.26 : 3.68	3.26 : 3.68	3.29 : 3.53
2.72	2.65	2.65	2.81
3.50 : 3.68	4.30 : 4.35	4.30 : 4.35	4.86 : 5.10
4.92 : 5.17	4.29 : 4.69	4.29 : 4.69	4.21 : 4.61
4.49 : 4.40	3.92 : 4.07	3.92 : 4.07	3.80 : 3.99
4.60 : 3.90	4.03 : 3.62	4.03 : 3.62	3.85 : 3.55
5.36 : 5.23	4.63 : 4.74	4.63 : 4.74	4.53 : 4.63
5.55 : 4.80	4.60 : 4.39	4.60 : 4.39	4.54 : 4.28
5.97 : 4.31	4.91 : 3.96	4.91 : 3.96	4.80 : 3.88
1 Phase / 50Hz 230V   240V - <sup>1</sup>	1 Phase / 50Hz 230V   240V - <sup>1</sup>	1 Phase / 50Hz 230V   240V - <sup>1</sup>	1 Phase / 50Hz 230V   240V 2.41 : 2.41   2.38 : 2.38
430 X 1,200 X 700	430 X 1,200 X 700	430 X 1,200 X 700	430 X 1,200 X 700
41	50	50	50
835 / 768 / 601 : 835 / 768 / 601	1,002 / 835 / 701 : 1,002 / 835 / 701	1,002 / 835 / 701 : 1,002 / 835 / 701	1,002 / 835 / 701 : 1,002 / 835 / 701
100 (10 - 150)	100 (50 - 150*)	100 (50 - 150*)	100 (50 - 150*)
49 / 47 / 45 : 49 / 47 / 45	51 / 49 / 47 : 51 / 49 / 47	51 / 49 / 47 : 51 / 49 / 47	51 / 49 / 47 : 51 / 49 / 47
71 / 69 / 67 : 71 / 69 / 67	73 / 71 / 69 : 73 / 71 / 69	73 / 71 / 69 : 73 / 71 / 69	73 / 71 / 69 : 73 / 71 / 69
3	3	3	3
VP-25	VP-25	VP-25	VP-25
3 Phase / 50Hz 400V   415V 5.60 : 5.90   5.40 : 5.70	1 Phase / 50Hz 230V   240V 19.7 : 19.9   18.9 : 19.1	3 Phase / 50Hz 400V   415V 6.60 : 6.70   6.35 : 6.45	1 Phase / 50Hz 230V   240V 20.0 : 21.1   19.1 : 20.1
1,416 x 940 x 340	1,416 x 940 x 340	1,416 x 940 x 340	1,500 x 980 x 370
99	99	99	117
2,087 : 1,870	2,154 : 1,937	2,154 : 1,937	2,738 : 2,738
53 (51) : 53 (51)	54 (52) : 54 (52)	54 (52) : 54 (52)	58 (56) : 60 (58)
69 (67) : 69 (67)	70 (68) : 70 (68)	70 (68) : 70 (68)	76 (74) : 78 (76)
Ø9.52 / Ø15.88	Ø9.52 / Ø15.88	Ø9.52 / Ø15.88	Ø9.52 / Ø19.05
5 - 85	5 - 85	5 - 85	5 - 75
15, 30	15, 30	15, 30	30, 30
30	30	30	30
R32 3,050 / 45 (g/m)	R32 3,050 / 45 (g/m)	R32 3,050 / 45 (g/m)	R32 3,200 / 45 (g/m)
-15 to 48 : -20 to 24	-15 to 48 : -20 to 24	-15 to 48 : -20 to 24	-15 to 46 : -20 to 24

12.5kW		14.0kW	
S-125PE3R	S-125PE3R	S-140PE3R	S-140PE3R
U-125PZ3R5	U-125PZ3R8	U-140PZ3R5	U-140PZ3R8
12.5 (3.2 - 13.5) <b>12.5 (3.3 - 15.0)</b>	12.5 (3.2 - 13.5) <b>12.5 (3.3 - 15.0)</b>	14.0 (3.3 - 15.0) <b>14.0 (3.4 - 16.0)</b>	14.0 (3.3 - 15.0) <b>14.0 (3.4 - 16.0)</b>
42,700 (10,900 - 46,100) <b>42,700 (11,300 - 51,200)</b>	42,700 (10,900 - 46,100) <b>42,700 (11,300 - 51,200)</b>	47,800 (11,300 - 51,200) <b>47,800 (11,600 - 54,600)</b>	47,800 (11,300 - 51,200) <b>47,800 (11,600 - 54,600)</b>
3.55 : 4.03	3.55 : 4.03	3.25 : 3.76	3.25 : 3.76
2.56	2.56	2.68	2.68
3.52 : 3.10	3.52 : 3.10	4.31 : 3.72	4.31 : 3.72
4.60 : 3.93	4.60 : 3.93	4.27 : 3.79	4.27 : 3.79
4.16 : 3.79	4.16 : 3.79	3.92 : 3.64	3.92 : 3.64
4.26 : 3.47	4.26 : 3.47	4.03 : 3.34	4.03 : 3.34
4.96 : 3.84	4.96 : 3.84	4.56 : 3.70	4.56 : 3.70
4.88 : 3.73	4.88 : 3.73	4.53 : 3.58	4.53 : 3.58
5.20 : 3.52	5.20 : 3.52	4.81 : 3.40	4.81 : 3.40
1 Phase / 50Hz 230V   240V 430 x 1,200 x 700	1 Phase / 50Hz 230V   240V 430 x 1,200 x 700	1 Phase / 50Hz 230V   240V 430 x 1,200 x 700	1 Phase / 50Hz 230V   240V 430 x 1,200 x 700
41	41	50	50
835 / 768 / 601 : 835 / 768 / 601	835 / 768 / 601 : 835 / 768 / 601	1,002 / 835 / 701 : 1,002 / 835 / 701	1,002 / 835 / 701 : 1,002 / 835 / 701
100 (10 - 150)	100 (10 - 150)	100 (50 - 150*)	100 (50 - 150*)
49 / 47 / 45 : 49 / 47 / 45	49 / 47 / 45 : 49 / 47 / 45	51 / 49 / 47 : 51 / 49 / 47	51 / 49 / 47 : 51 / 49 / 47
71 / 69 / 67 : 71 / 69 / 67	71 / 69 / 67 : 71 / 69 / 67	73 / 71 / 69 : 73 / 71 / 69	73 / 71 / 69 : 73 / 71 / 69
3	3	3	3
VP-25	VP-25	VP-25	VP-25
1 Phase / 50Hz 230V   240V 17.0 : 15.0   16.3 : 14.4	3 Phase / 50Hz 400V   415V 5.40 : 4.80   5.20 : 4.55	1 Phase / 50Hz 230V   240V 19.7 : 17.0   18.9 : 16.3	3 Phase / 50Hz 400V   415V 6.60 : 5.70   6.40 : 5.50
996 x 980 x 370	996 x 980 x 370	996 x 980 x 370	996 x 980 x 370
87	87	87	87
1,369 : 1,336	1,369 : 1,336	1,402 : 1,369	1,402 : 1,369
55 (53) : 55 (53)	55 (53) : 55 (53)	56 (54) : 56 (54)	56 (54) : 56 (54)
73 (71) : 73 (71)	73 (71) : 73 (71)	74 (72) : 74 (72)	74 (72) : 74 (72)
Ø9.52 / Ø15.88	Ø9.52 / Ø15.88	Ø9.52 / Ø15.88	Ø9.52 / Ø15.88
5 - 50	5 - 50	5 - 50	5 - 50
15, 30	15, 30	15, 30	15, 30
30	30	30	30
R32 2,800 / 45 (g/m)	R32 2,800 / 45 (g/m)	R32 2,800 / 45 (g/m)	R32 2,800 / 45 (g/m)
-10 to 46 : -15 to 24	-10 to 46 : -15 to 24	-10 to 46 : -15 to 24	-10 to 46 : -15 to 24

Notes:

- In the case of nanoe X OFF
- In case it is necessary to indicate the air flow volume in (l/s), the value in (m<sup>3</sup>/min.) shall be multiplied by 16.7 and rounded down the decimal point.
- AEER and ACOP classification is at 230V(400V) only in accordance with GEMS2019.
- TCSPF, HSPF and Total Energy consumption indicate the value of average temperature zone.
- Indoor and outdoor sound levels are determined in an anechoic chamber and may differ once the unit is installed due to ambient conditions.
- <sup>1</sup> Outdoor power supply.
- <sup>2</sup> Not adjustable, refer to "Indoor Fan Performance" section of technical data.
- <sup>3</sup> For piping connection for 6.0kW unit, connect the gas socket tube (Ø12.7-Ø15.88) to the gas tubing side indoor unit and connect the liquid socket tube (Ø6.35-Ø9.52) to the liquid tubing side indoor unit.
- <sup>4</sup> For piping connection for 7.1kW unit, connect the liquid socket tube (Ø6.35-Ø9.52) to the liquid tubing side indoor unit.

# Indoor Unit

## High Static Pressure

# Adaptive Ducted

Control all aspects of your environment with exceptional performance and quiet operation. Vertical installation flexibility offers the perfect solution when ceiling heights are restricted.

**nanoe™ X**  
 nanoe™ X as a standard\*  
\*nanoe X Generator Mark 2

**ECONAVI**

ECONAVI ready

-   
Self-diagnosing Function
-   
Automatic Fan Operation
-   
Dry mode
-   
Automatic Restart Function
-   
Built-in Drain Pump
-   
DC Motor

### Technical focus

- Space saving 250mm height
- Accurate temperature control to reduce cold drafts during operation
- DC fan motor for variable external static pressure control
- Configurable air temperature control
- Easy to install and maintain

### Variable external static pressure control

Optimal airflow set-up is possible for different ducting design and conditions.

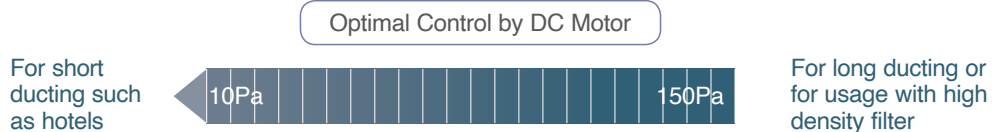

Note: Please refer to technical documents for detail.

### Powerful 150Pa external static pressure in an industry-leading vertical installation design

Delivering static pressure up to 150Pa external static pressure, the industry-leading horizontal/vertical design offers the power you need in a compact form factor.

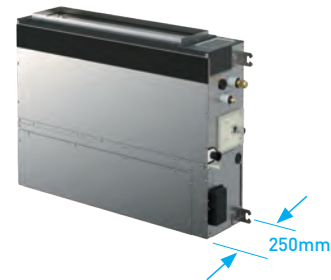

### Selectable air inlet position

A removable panel allows air inlet position to be adjusted to enable rear or bottom entry, depending on ductwork installation.

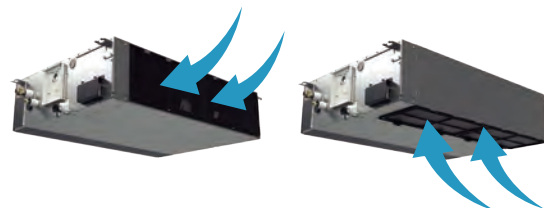



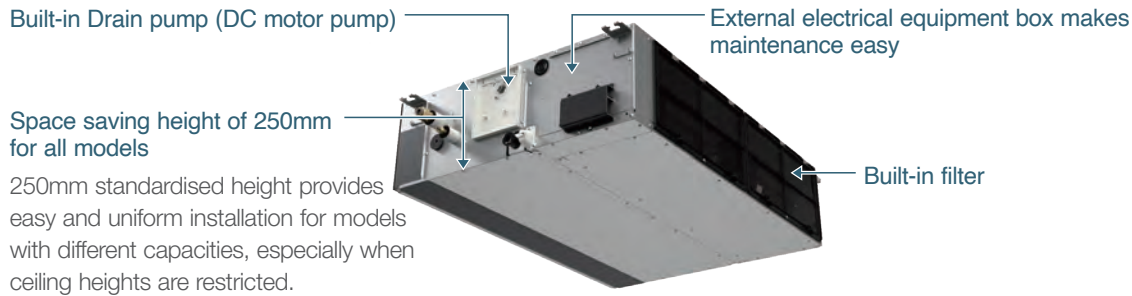

## Top-class noise level performance

A proprietary improved casing design realises an even smoother airflow and low noise (22dB - 29dB) operation while effortlessly maintaining enough pressure\*2 to deliver quiet comfort ideal for hotel and guest rooms.

\*2 Operating at 50Pa static pressure in Low fan mode.

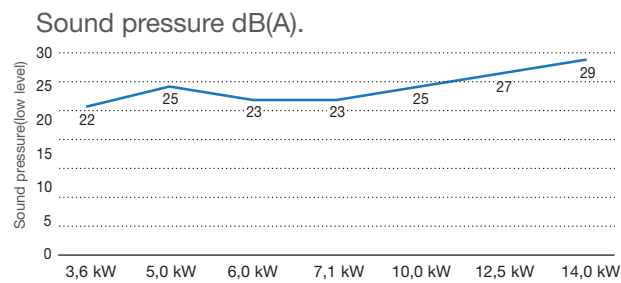
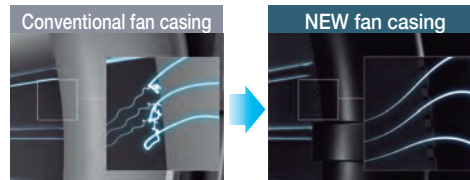

Note: Silent operation in full rated capacity.

## Superior air quality

The new ducted models are equipped with nanoe™ X as standard, a unique air quality improvement technology producing twice the amount of hydroxyl radicals compared to previous generations. Combined with the strong static pressure this ensures pristine nanoe™ X air travels unaffected even through multiple duct shapes at lengths of 10m, as well as making them ideal for use in larger spaces.

Note: PF3 and PE3 (16.0kW and below) ranges only.



Based on in-house test result, even with a total ductwork length up to 10m, effectiveness of nanoe™ X is maintained.

# Indoor Unit: High Static Pressure Adaptive Ducted

## Specifications of R32 Deluxe Model

Capacity		6.8kW		9.5kW		12.1kW		
Model Name		S-6071PF3E		S-1014PF3E		S-1014PF3E		
		Outdoor Unit		U-71PZH3R5		U-100PZH3R5		
Cooling capacity :	kW	6.8 (2.2 - 7.8)		9.5 (3.1 - 11.4)		9.5 (3.1 - 11.4)		
		7.5 (2.0 - 9.0)		10.8 (3.1 - 13.5)		13.5 (3.2 - 15.4)		
Heating capacity	BTU/h	23,200 (7,500 - 26,600)		32,400 (10,600 - 38,900)		32,400 (10,600 - 38,900)		
		25,600 (6,800 - 30,700)		36,800 (10,600 - 46,100)		46,100 (10,900 - 52,500)		
EER : COP	W/W	3.74 : 4.03		4.17 : 3.97		4.17 : 3.97		
COP@H2 condition	W/W	2.96		2.90		2.90		
Total power input	kW	1.82 : 1.86		2.28 : 2.72		2.28 : 2.72		
		5.40 : 5.49		5.93 : 5.57		5.93 : 5.57		
TCSPF : HSPF	Residential	Average Climate	4.75 : 4.67		5.21 : 4.70		5.21 : 4.70	
		Cold Climate	4.82 : 4.13		5.29 : 4.21		5.29 : 4.21	
		Hot Climate	6.02 : 5.54		6.59 : 5.61		6.59 : 5.61	
	Commercial	Average Climate	6.25 : 5.08		6.75 : 5.13		6.75 : 5.13	
		Cold Climate	6.76 : 4.56		7.28 : 4.65		7.28 : 4.65	
		Hot Climate	5.40 : 5.49		5.93 : 5.57		5.93 : 5.57	
Indoor Unit		Phase/Hz		1 Phase / 50Hz		1 Phase / 50Hz		
Power source		V		230V   240V		230V   240V		
Dimension		H x W x D		250 x 1,000 x 730		250 x 1,400 x 730		
Net weight		Indoor		kg		30		
Air volume (H/M/L)		Cooling : Heating		L/s		350 / 317 / 250 : 350 / 317 / 250		
External static pressure		Pa		30 (10 - 150)		40 (10 - 150)		
Sound pressure level (H/M/L)		Cooling : Heating		dB(A)		30 / 26 / 23 : 30 / 26 / 23		
Sound power level (H/M/L)		Cooling : Heating		dB		53 / 49 / 46 : 53 / 49 / 46		
Number of fan speeds		5		5		5		
Drain piping		mm		VP-20		VP-20		
Outdoor Unit		Phase/Hz		1 Phase / 50Hz		1 Phase / 50Hz		
Power source		V		230V   240V		230V   240V		
Current (rated)		Cooling : Heating		A		8.60 : 8.60   8.25 : 8.35		
Dimensions		H x W x D		mm		996 x 940 x 340		
Net weight		kg		66		99		
Air volume		Cooling : Heating		L/s		1,018 : 1,002		
Sound pressure level (Silent mode)		Cooling : Heating		dB(A)		48 (46) : 50 (48)		
Sound power level (Silent mode)		Cooling : Heating		dB		64 (62) : 66 (64)		
Piping connections		Liquid / Gas		mm		Ø9.52 / Ø15.88		
Pipe length range		min. - max.		m		5 - 50		
Elevation difference (OU located lower, OU located higher)		m		15, 30		15, 30		
Maximum chargeless length		m		30		30		
Refrigerant at shipping / Additional gas amount		g		R32 1,950 / 45 (g/m)		R32 3,050 / 45 (g/m)		
Operation ranges		Cooling : Heating		°C		-15 to 48 : -20 to 24		

## Specifications of R32 Compact Model

Capacity		3.4kW		4.6kW		5.7kW		6.8kW		
Model Name		S-3650PF3E		S-3650PF3E		S-6071PF3E		S-6071PF3E		
		Outdoor Unit		U-36PZ3R5		U-50PZ3R5		U-71PZ3R5		
Cooling capacity :	kW	3.4 (1.3 - 4.0)		4.6 (1.5 - 5.3)		5.7 (2.0 - 6.3)		6.8 (2.6 - 7.7)		
		3.6 (1.3 - 4.6)		5.0 (1.5 - 5.9)		5.7 (1.8 - 7.0)		6.8 (2.1 - 8.1)		
Heating capacity	BTU/h	11,600 (4,400 - 13,600)		15,700 (5,100 - 18,100)		19,400 (6,800 - 21,500)		23,200 (8,900 - 26,300)		
		12,300 (4,400 - 15,700)		17,100 (5,100 - 20,100)		19,400 (6,100 - 23,900)		23,200 (7,200 - 27,600)		
EER : COP	W/W	3.78 : 4.29		3.19 : 3.62		3.54 : 4.04		3.18 : 4.00		
COP@H2 condition	W/W	3.09		3.33		3.09		2.84		
Total power input	kW	0.900 : 0.840		1.44 : 1.38		1.61 : 1.41		2.14 : 1.70		
		5.11 : 5.05		4.67 : 5.09		5.19 : 5.76		4.57 : 5.26		
TCSPF : HSPF	Residential	Average Climate	4.36 : 4.57		4.23 : 4.31		4.67 : 4.83		4.23 : 4.42	
		Cold Climate	4.36 : 4.06		4.29 : 3.79		4.82 : 4.13		4.34 : 3.82	
		Hot Climate	5.77 : 5.01		5.22 : 5.13		5.69 : 5.77		5.01 : 5.33	
	Commercial	Average Climate	5.84 : 4.72		5.96 : 4.69		6.00 : 5.23		5.53 : 4.86	
		Cold Climate	6.41 : 4.31		6.69 : 4.19		6.54 : 4.60		6.11 : 4.27	
		Hot Climate	5.40 : 5.49		5.93 : 5.57		5.93 : 5.57		5.93 : 5.57	
Indoor Unit		Phase/Hz		1 Phase / 50Hz		1 Phase / 50Hz		1 Phase / 50Hz		
Power source		V		230V   240V		230V   240V		230V   240V		
Dimensions		H x W x D		250 x 800 x 730		250 x 800 x 730		250 x 1,000 x 730		
Net weight		Indoor		kg		25		30		
Air volume (H/M/L)		Cooling : Heating		L/s		233 / 217 / 167 : 233 / 217 / 167		350 / 317 / 250 : 350 / 317 / 250		
External static pressure		Pa		30 (10 - 150)		30 (10 - 150)		30 (10 - 150)		
Sound pressure level (H/M/L)		Cooling : Heating		dB(A)		30 / 27 / 22 : 30 / 27 / 22		30 / 26 / 23 : 30 / 26 / 23		
Sound power level (H/M/L)		Cooling : Heating		dB		53 / 50 / 45 : 53 / 50 / 45		53 / 49 / 46 : 53 / 49 / 46		
Number of fan speeds		5		5		5		5		
Drain piping		mm		VP-20		VP-20		VP-20		
Outdoor Unit		Phase/Hz		1 Phase / 50Hz		1 Phase / 50Hz		1 Phase / 50Hz		
Power source		V		230V   240V		230V   240V		230V   240V		
Current (rated)		Cooling : Heating		A		4.00 : 3.80   3.85 : 3.55		6.40 : 6.20   6.10 : 5.95		
Dimensions		H x W x D		mm		619 x 824 x 299		695 x 875 x 320		
Net weight		kg		31		43		50		
Air volume		Cooling : Heating		L/s		561 : 567		701 : 701		
Sound pressure level (Silent mode)		Cooling : Heating		dB(A)		48 (46) : 49 (47)		48 (46) : 49 (47)		
Sound power level (Silent mode)		Cooling : Heating		dB		66 (64) : 67 (65)		66 (64) : 67 (65)		
Piping connections		Liquid / Gas		mm		Ø6.35 / Ø12.7		Ø6.35 / Ø12.7 <sup>1</sup>		
Pipe length range		min. - max.		m		3 - 20		3 - 40		
Elevation difference (OU located lower, OU located higher)		m		15, 15		15, 30		15, 30		
Maximum chargeless length		m		7.5		10		30		
Refrigerant at shipping, Additional gas amount		g		R32 870 / 10 (g/m)		R32 1,140 / 15 (g/m)		R32 1,130 / 15 (g/m)		
Operating range		Cooling : Heating		°C		-10 to 46 : -15 to 24		-10 to 46 : -15 to 24		

13.4kW		
S-1014PF3E	S-1014PF3E	S-1014PF3E
U-125PZH3R8	U-140PZH3R5	U-140PZH3R8
12.1 (3.2 - 13.6) <b>13.5 (3.2 - 15.4)</b>	13.4 (3.3 - 15.3) <b>15.5 (3.3 - 17.4)</b>	13.4 (3.3 - 15.3) <b>15.5 (3.3 - 17.4)</b>
41,300 (10,900 - 46,400) <b>46,100 (10,900 - 52,500)</b>	45,700 (11,300 - 52,200) <b>52,900 (11,300 - 59,400)</b>	45,700 (11,300 - 52,200) <b>52,900 (11,300 - 59,400)</b>
3.58 : 3.46	3.38 : 3.44	3.38 : 3.44
2.60	2.68	2.68
3.38 : 3.90	3.96 : 4.51	3.96 : 4.51
5.37 : 5.32	4.98 : 4.97	4.98 : 4.97
4.86 : 4.32	4.55 : 4.15	4.55 : 4.15
5.03 : 3.79	4.72 : 3.65	4.72 : 3.65
5.95 : 5.44	5.49 : 5.05	5.49 : 5.05
6.30 : 4.87	5.74 : 4.58	5.74 : 4.58
6.88 : 4.31	6.25 : 4.08	6.25 : 4.08
1 Phase / 50Hz 230V   240V 250 X 1,400 X 730 39 567 / 484 / 384 : <b>567 / 484 / 384</b> 50 (10 - 150) 35 / 31 / 27 : <b>35 / 31 / 27</b> 58 / 54 / 50 : <b>58 / 54 / 50</b> 5 VP-20	1 Phase / 50Hz 230V   240V 250 X 1,400 X 730 39 601 / 534 / 417 : <b>601 / 534 / 417</b> 50 (10 - 150) 39 / 35 / 29 : <b>39 / 35 / 29</b> 62 / 58 / 52 : <b>62 / 58 / 52</b> 5 VP-20	1 Phase / 50Hz 230V   240V 250 X 1,400 X 730 39 601 / 534 / 417 : <b>601 / 534 / 417</b> 50 (10 - 150) 39 / 35 / 29 : <b>39 / 35 / 29</b> 62 / 58 / 52 : <b>62 / 58 / 52</b> 5 VP-20
3 Phase / 50Hz 400V   415V 5.30 : <b>6.10</b>   5.15 : <b>5.90</b> 1,416 x 940 x 340 99 2,087 : <b>1,870</b> 53 (51) : <b>53 (51)</b> 69 (67) : <b>69 (67)</b> Ø9.52 / Ø15.88 5 - 85 15, 30 30 R32 3,050 / 45 (g/m) -15 to 48 : <b>-20 to 24</b>	1 Phase / 50Hz 230V   240V 18.7 : <b>21.1</b>   17.9 : <b>20.2</b> 1,416 x 940 x 340 99 2,154 : <b>1,937</b> 54 (52) : <b>54 (52)</b> 70 (68) : <b>70 (68)</b> Ø9.52 / Ø15.88 5 - 85 15, 30 30 R32 3,050 / 45 (g/m) -15 to 48 : <b>-20 to 24</b>	3 Phase / 50Hz 400V   415V 6.30 : <b>7.15</b>   6.05 : <b>6.90</b> 1,416 x 940 x 340 99 2,154 : <b>1,937</b> 54 (52) : <b>54 (52)</b> 70 (68) : <b>70 (68)</b> Ø9.52 / Ø15.88 5 - 85 15, 30 30 R32 3,050 / 45 (g/m) -15 to 48 : <b>-20 to 24</b>

Notes:

- In the case of standard installation (Horizontal installation in the ceiling, rear side air intake)
- In the case of nanoe X OFF
- In case it is necessary to indicate the air flow volume in (l/s), the value in (m³/min.) shall be multiplied by 16.7 and rounded down the decimal point.
- AEER and ACOP classification is at 230V(400V) only in accordance with GEMS2019.
- TCSPF, HSPF and Total Energy consumption indicate the value of average temperature zone.
- Indoor and outdoor sound levels are determined in an anechoic chamber and may differ once the unit is installed due to ambient conditions
- H : High at setting 5 stage (Level 5), M : Middle at setting 5 stage (Level 3), L : Low at setting 5 stage (Level 1) Noise of L is indicated by the values at FAN mode.

\*1 For piping connection for 6.0kW unit, connect the gas socket tube (Ø12.7-Ø15.88) to the gas tubing side indoor unit and connect the liquid socket tube (Ø6.35-Ø9.52) to the liquid tubing side indoor unit.

\*2 For piping connection for 7.1kW unit, connect the liquid socket tube (Ø6.35-Ø9.52) to the liquid tubing side indoor unit.

9.5kW		12.1kW		13.4kW	
S-1014PF3E	S-1014PF3E	S-1014PF3E	S-1014PF3E	S-1014PF3E	S-1014PF3E
U-100PZ3R5	U-100PZ3R8	U-125PZ3R5	U-125PZ3R8	U-140PZ3R5	U-140PZ3R8
9.5 (3.0 - 11.4) <b>9.5 (3.0 - 13.5)</b>	9.5 (3.0 - 11.4) <b>9.5 (3.0 - 13.5)</b>	12.1 (3.2 - 13.5) <b>12.1 (3.3 - 15.0)</b>	12.1 (3.2 - 13.5) <b>12.1 (3.3 - 15.0)</b>	13.4 (3.3 - 15.0) <b>13.4 (3.4 - 16.0)</b>	13.4 (3.3 - 15.0) <b>13.4 (3.4 - 16.0)</b>
32,400 (10,200 - 38,900) <b>32,400 (10,200 - 46,100)</b>	32,400 (10,200 - 38,900) <b>32,400 (10,200 - 46,100)</b>	41,300 (10,900 - 46,100) <b>41,300 (11,300 - 51,200)</b>	41,300 (10,900 - 46,100) <b>41,300 (11,300 - 51,200)</b>	45,700 (11,300 - 51,200) <b>45,700 (11,600 - 54,600)</b>	45,700 (11,300 - 51,200) <b>45,700 (11,600 - 54,600)</b>
3.57 : 4.09	3.57 : 4.09	3.40 : 3.56	3.40 : 3.56	3.16 : 3.76	3.16 : 3.76
2.88	2.88	2.82	2.82	2.73	2.73
2.66 : 2.32	2.66 : 2.32	3.56 : 3.40	3.56 : 3.40	4.24 : 3.56	4.24 : 3.56
5.24 : 5.04	5.24 : 5.04	4.90 : 5.01	4.90 : 5.01	4.75 : 4.93	4.75 : 4.93
4.52 : 4.52	4.52 : 4.52	4.42 : 4.21	4.42 : 4.21	4.33 : 4.18	4.33 : 4.18
4.62 : 4.06	4.62 : 4.06	4.52 : 3.68	4.52 : 3.68	4.47 : 3.63	4.47 : 3.63
5.87 : 4.99	5.87 : 4.99	5.40 : 5.06	5.40 : 5.06	5.26 : 5.01	5.26 : 5.01
5.91 : 4.68	5.91 : 4.68	5.81 : 4.60	5.81 : 4.60	5.78 : 4.59	5.78 : 4.59
6.49 : 4.31	6.49 : 4.31	6.36 : 4.10	6.36 : 4.10	6.40 : 4.05	6.40 : 4.05
1 Phase / 50Hz 230V   240V 250 x 1,400 x 730 39 534 / 434 / 350 : <b>534 / 434 / 350</b> 40 (10 - 150) 33 / 29 / 25 : <b>33 / 29 / 25</b> 56 / 52 / 48 : <b>56 / 52 / 48</b> 5 VP-20	1 Phase / 50Hz 230V   240V 250 x 1,400 x 730 39 534 / 434 / 350 : <b>534 / 434 / 350</b> 40 (10 - 150) 33 / 29 / 25 : <b>33 / 29 / 25</b> 56 / 52 / 48 : <b>56 / 52 / 48</b> 5 VP-20	1 Phase / 50Hz 230V   240V 250 x 1,400 x 730 39 567 / 484 / 384 : <b>567 / 484 / 384</b> 50 (10 - 150) 35 / 31 / 27 : <b>35 / 31 / 27</b> 58 / 54 / 50 : <b>58 / 54 / 50</b> 5 VP-20	1 Phase / 50Hz 230V   240V 250 x 1,400 x 730 39 567 / 484 / 384 : <b>567 / 484 / 384</b> 50 (10 - 150) 35 / 31 / 27 : <b>35 / 31 / 27</b> 58 / 54 / 50 : <b>58 / 54 / 50</b> 5 VP-20	1 Phase / 50Hz 230V   240V 250 x 1,400 x 730 39 601 / 534 / 417 : <b>601 / 534 / 417</b> 50 (10 - 150) 39 / 35 / 29 : <b>39 / 35 / 29</b> 62 / 58 / 52 : <b>62 / 58 / 52</b> 5 VP-20	1 Phase / 50Hz 230V   240V 250 x 1,400 x 730 39 601 / 534 / 417 : <b>601 / 534 / 417</b> 50 (10 - 150) 39 / 35 / 29 : <b>39 / 35 / 29</b> 62 / 58 / 52 : <b>62 / 58 / 52</b> 5 VP-20
1 Phase / 50Hz 230V   240V 12.7 : <b>11.1</b>   12.2 : <b>10.6</b> 996 x 980 x 370 83 1,219 : <b>1,219</b> 52 (50) : <b>52 (50)</b> 70 (68) : <b>70 (68)</b> Ø9.52 / Ø15.88 5 - 50 15, 30 30 R32 2,400 / 45 (g/m) -10 to 46 : <b>-15 to 24</b>	3 Phase / 50Hz 400V   415V 4.20 : <b>3.70</b>   4.05 : <b>3.55</b> 996 x 980 x 370 83 1,219 : <b>1,219</b> 52 (50) : <b>52 (50)</b> 70 (68) : <b>70 (68)</b> Ø9.52 / Ø15.88 5 - 50 15, 30 30 R32 2,400 / 45 (g/m) -10 to 46 : <b>-15 to 24</b>	1 Phase / 50Hz 230V   240V 16.5 : <b>15.7</b>   15.8 : <b>15.1</b> 996 x 980 x 370 87 1,369 : <b>1,336</b> 55 (53) : <b>55 (53)</b> 73 (71) : <b>73 (71)</b> Ø9.52 / Ø15.88 5 - 50 15, 30 30 R32 2,800 / 45 (g/m) -10 to 46 : <b>-15 to 24</b>	3 Phase / 50Hz 400V   415V 5.45 : <b>5.20</b>   5.25 : <b>5.05</b> 996 x 980 x 370 87 1,369 : <b>1,336</b> 55 (53) : <b>55 (53)</b> 73 (71) : <b>73 (71)</b> Ø9.52 / Ø15.88 5 - 50 15, 30 30 R32 2,800 / 45 (g/m) -10 to 46 : <b>-15 to 24</b>	1 Phase / 50Hz 230V   240V 19.6 : <b>16.5</b>   18.8 : <b>15.8</b> 996 x 980 x 370 87 1,402 : <b>1,369</b> 56 (54) : <b>56 (54)</b> 74 (72) : <b>74 (72)</b> Ø9.52 / Ø15.88 5 - 50 15, 30 30 R32 2,800 / 45 (g/m) -10 to 46 : <b>-15 to 24</b>	3 Phase / 50Hz 400V   415V 6.50 : <b>5.45</b>   6.30 : <b>5.25</b> 996 x 980 x 370 87 1,402 : <b>1,369</b> 56 (54) : <b>56 (54)</b> 74 (72) : <b>74 (72)</b> Ø9.52 / Ø15.88 5 - 50 15, 30 30 R32 2,800 / 45 (g/m) -10 to 46 : <b>-15 to 24</b>

# Multi-Split Air Conditioning System

Panasonic's multi-split conditioning systems are designed to provide more space saving installation for outdoor units. A neater alternative to preserve the exterior appearance of buildings such as condominiums, single and multi-storey residences.



Compact and lightweight design to fit every building type

- The multi-split system offers greater installation versatility and space-saving choices for condominium with limited free space.

## WALL-MOUNTED – AERO Z SERIES



Model No	CS-220XKRW	CS-225XKRW-1	CS-235XKRW	CS-242XKRW
Capacity	2.0kW	2.5kW	3.5kW	4.2kW**

Model No	CS-250XKRW	CS-250XKRW-1	CS-260XKRW-1	CS-271XKRW
Capacity	5.0kW**	5.0kW**	6.0kW**	7.1kW****

## MINI CASSETTE WITH nano™ X

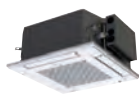

Model No	S-25PY3E	S-34PY3E	S-50PY3E	S-60PY3E
Capacity	2.5kW**	3.5kW**	5.0kW**	6.0kW**

## WALL-MOUNTED – DEVELOPER RZ SERIES



Model No	CS-MRZ16WR	CS-MRZ20WR	CS-RZ25XKRW	CS-RZ35XKRW
Capacity	1.6kW	2.0kW	2.5kW	3.5kW

Model No	CS-RZ42XKRW	CS-RZ50XKRW	CS-RZ60XKRW	CS-RZ71XKRW
Capacity	4.2kW**	5.0kW**	6.0kW**	7.1kW****

## PREMIER SERIES FLOOR CONSOLE



Model No	CS-Z25UFRAW	CS-Z35UFRAW	CS-Z50UFRAW
Capacity	2.5kW	3.5kW	5.0kW**

## ULTRA SLIM DUCTED



Model No	CS-Z25UD3RAW	CS-Z35UD3RAW	CS-Z50UD3RAW	CS-Z60UD3RAW
Capacity	2.5kW	3.5kW	5.0kW**	6.0kW**

# Advantages Of Multi-Split Air Conditioning System

## Space Saving

### Multi Split

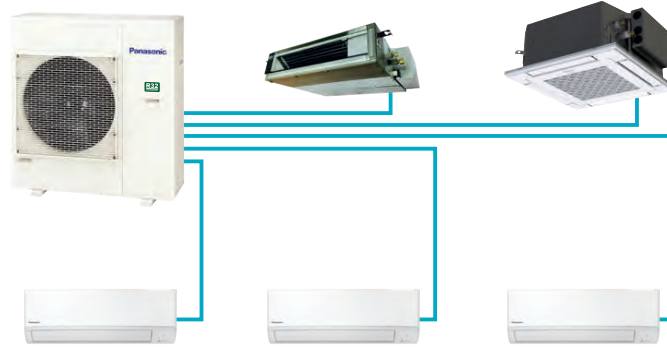

Space-saving installation with less outdoor units required

- As 1 outdoor unit is able to connect up to 5 indoor units, this provide flexible customization according to the layout of your house.

## Independent Operation Control

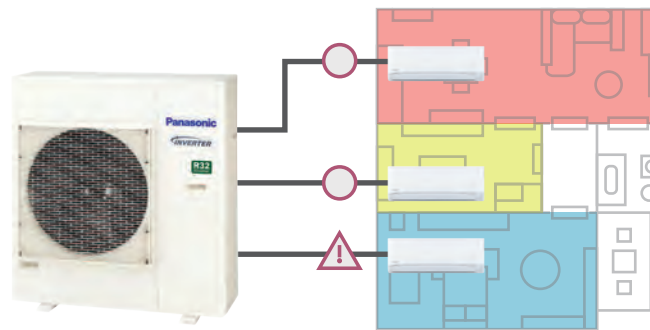

Outdoor unit connects to each indoor unit independently

- Able to adjust the operation settings for each indoor unit separately. If one indoor unit is malfunctions, other indoor units can continue to operate by provide cooling comfort to the rooms.

## Flexible Installation

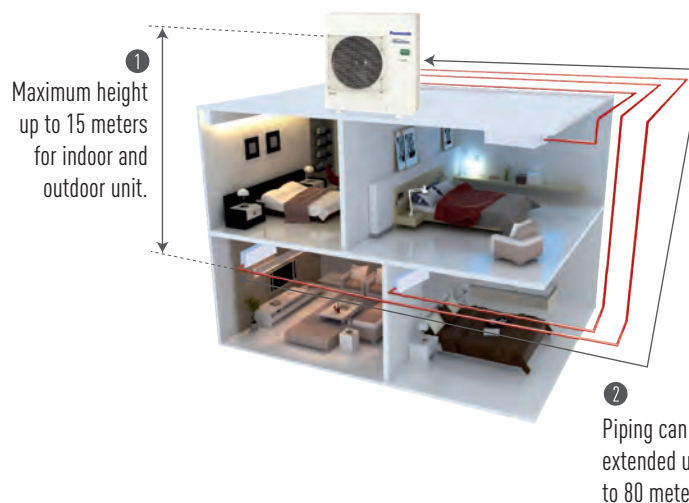

The multi-split system accommodates long pipelines up to 80 meters

- Flexible arrangement and installation of indoor and outdoor units based on the room condition, location and installation convenience of the site.

\* Applicable to CU-5Z100VBR

Product Line-Up

MODEL	Indoor Units Combination Range	Refrigerant Pipe Diameter			Pipe Extension					Indoor Unit Combinations				
		Indoor Unit	Liquid Side (mm)	Gas Side (mm)	Maximum Pipe Length (1 room)	Maximum Pipe Length (Total)	Maximum Chargeless Length	Additional Gas	Maximum Height	Type Capacity [kW class]	Wall-Mounted	Cassette	Ultra Slim Ducted	Floor Console
<p><b>CU-2Z52VBR</b></p> <p><b>INDOOR UNITS: Possible Combination Patterns</b> Must be within capacity range</p> <p>5.2kW *4</p> <p>Dimensions (HxWxD): 619 x 824(+70) x 299 mm Weight: 39 kg</p> <p>* At least two indoor units must be connected.</p>	3.2 to 7.7 kW	Room A	ø 6.35	ø 9.52	20 m	30 m	20 m	15 g/m	10 m	1.6	●			
										2.0	●			
		2.5	●	●						●	●			
		3.5	●	●						●	●			
		4.2	●											
		5.0	●	●						●	●			
<p><b>CU-3Z54VBR</b></p> <p><b>INDOOR UNITS: Possible Combination Patterns</b> Must be within capacity range</p> <p>5.4kW *4</p> <p>Dimensions (HxWxD): 795 x 875(+95) x 320 mm Weight: 71 kg</p> <p>* At least two indoor units must be connected.</p>	4.5 to 9.5 kW	Room A	ø 6.35	ø 9.52	25 m	50 m	30 m	20 g/m	15 m	1.6	●			
										2.0	●			
		2.5	●	●						●	●			
		3.5	●	●						●	●			
		4.2	●											
		5.0	●	●						●	●			
<p><b>CU-4Z71VBR</b></p> <p><b>INDOOR UNITS: Possible Combination Patterns</b> Must be within capacity range</p> <p>7.1kW *4</p> <p>Dimensions (HxWxD): 795 x 875(+95) x 320 mm Weight: 72 kg</p> <p>* At least two indoor units must be connected.</p>	4.5 to 11.5 kW	Room A	ø 6.35	ø 9.52	25 m	60 m	30 m	20 g/m	15 m	1.6	●			
										2.0	●			
		2.5	●	●						●	●			
		3.5	●	●						●	●			
		4.2	●											
		5.0	●	●						●	●			
6.0	●	●	●	●										

\*4 To enable demand response management, an optional accessory needs to be installed [CZ-CAP2]

OUTDOOR UNIT



Up to 2 rooms



CU-2Z52VBR

Up to 3 rooms



CU-3Z54VBR

Up to 4 rooms



CU-4Z71VBR

Product Line-Up

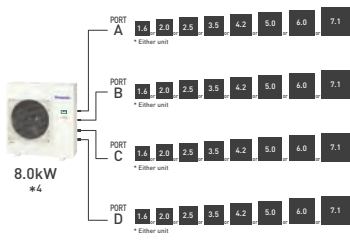
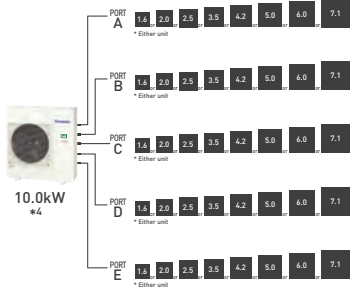
MODEL	Indoor Units Combination Range	Refrigerant Pipe Diameter			Pipe Extension					Indoor Unit Combinations				
		Indoor Unit	Liquid Side (mm)	Gas Side (mm)	Maximum Pipe Length (1 room)	Maximum Pipe Length (Total)	Maximum Chargeless Length	Additional Gas	Maximum Height	Type Capacity (kW class)	Wall- Mounted	Cassette	Ultra Slim Ducted	Floor Console
<p><b>CU-4Z80VBR</b></p> <p><b>INDOOR UNITS: Possible Combination Patterns</b> Must be within capacity range</p>  <p>8.0kW #4</p> <p>Dimensions (HxWxD): 999 x 940 x 340 mm Weight: 80 kg</p> <p>At least two indoor units must be connected.</p>	<p>4.5 to 14.7 kW</p>	Room A	ø 6.35	ø 9.52	25 m	70 m	45 m	20 g/m	15 m	1.6	●			
		Room B	ø 6.35	ø 9.52						2.0	●			
		Room C	ø 6.35	ø 9.52						2.5	●	●	●	●
		Room D	ø 6.35	ø 9.52						3.5	●	●	●	●
										4.2	●			
										5.0	●	●	●	●
										6.0	●	●	●	
										7.1	●			
<p><b>CU-5Z100VBR</b></p> <p><b>INDOOR UNITS: Possible Combination Patterns</b> Must be within capacity range</p>  <p>10.0kW #4</p> <p>Dimensions (HxWxD): 999 x 940 x 340 mm Weight: 81 kg</p> <p>At least two indoor units must be connected.</p>	<p>4.5 to 18.3 kW</p>	Room A	ø 6.35	ø 9.52	25 m	80 m	45 m	20 g/m	15 m	1.6	●			
		Room B	ø 6.35	ø 9.52						2.0	●			
		Room C	ø 6.35	ø 9.52						2.5	●	●	●	●
		Room D	ø 6.35	ø 9.52						3.5	●	●	●	●
										4.2	●			
										5.0	●	●	●	●
										6.0	●	●	●	
										7.1	●			

\*4 To enable demand response management, an optional accessory needs to be installed [CZ-CAP2]

ACCESSORIES



CZ-MA1PA

\*1 CZ-MA1PA is to be used to reduce the connection size on the indoor unit from 1/2" to 3/8".



CZ-MA2PA

\*2 CZ-MA2PA is to be used to increase the connection size on the outdoor unit from 3/8" to 1/2".



CZ-MA3PA

\*3 CZ-MA3PA is to be used to reduce the connection size on the indoor unit from 3/8" to 1/2".

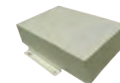

CZ-CAP2

\*4 Demand response module CZ-CAP2.

OUTDOOR UNIT



Up to 4 rooms



CU-4Z80VBR

Up to 5 rooms



CU-5Z100VBR

Product Line-Up

INDOOR UNIT

MODEL			WALL-MOUNTED (AERO Z SERIES)							
			CS-Z20XKRW	CS-Z25XKRW-1	CS-Z35XKRW	CS-Z42XKRW	CS-Z50XKRW	CS-Z50XKRW-1	CS-Z60XKRW-1	CS-Z71XKRW
Capacity	kW		2.0	2.5	3.5	4.2	5.0	5.0	6.0	7.1
Power Source			Single Phase 240V, 50Hz							
Sound Pressure Level (H/L/Q-Lo)	Cooling	dB(A)	40/26/21	42/27/21	46/28/21	46/33/30	46/36/30	49/36/33	50/38/35	51/39/36
	Heating		41/27/23	42/29/23	46/31/24	46/34/30	46/36/30*	49/35/31	50/37/34	51/39/36
Sound Power Level (H/L/Q-Lo)	Cooling	dB(A)	56/42/37	58/43/37	62/44/37	62/49/46	62/52/46	65/52/49	66/54/51	67/55/52
	Heating		57/43/39	58/45/39	62/47/40	62/50/46	62/52/46*	65/51/47	66/53/50	67/55/52
Airflow	Cooling/Heating	L/s	178/195	188/200	193/202	193/202	208/228	328/328	337/358	352/367
Dimensions	Height	mm	290	290	290	290	290	295	295	295
	Width	mm	779	779	779	779	779	1,040	1,040	1,040
	Depth	mm	209	209	209	209	209	244	244	244
Net Weight	kg		8	8	8	8	8	12	13	13
Refrigerant Pipe Diameter	Liquid Side	mm	ø 6.35	ø 6.35	ø 6.35	ø 6.35	ø 6.35	ø 6.35	ø 6.35	ø 6.35
	Gas Side	mm	ø 9.52	ø 9.52	ø 9.52	ø 9.52 <sup>1</sup>	ø 9.52 <sup>1</sup>	ø 9.52 <sup>1</sup>	ø 12.70 <sup>2</sup>	ø 12.70 <sup>2*3</sup>

\*For connection to CU-2252VBR, indoor Sound Pressure Level (Heating) is 46/35/31 and Sound Power Level (Heating) is 62/51/47.

MODEL			WALL-MOUNTED (DEVELOPER RZ SERIES)							
			CS-MRZ16WKR	CS-MRZ20WKR	CS-RZ25XKRW	CS-RZ35XKRW	CS-RZ42XKRW	CS-RZ50XKRW	CS-RZ60XKRW	CS-RZ71XKRW
Capacity	kW		1.6	2.0	2.5	3.5	4.2	5.0	6.0	7.1
Power Source			Single Phase 240V, 50Hz							
Sound Pressure Level (H/L/Q-Lo)	Cooling	dB(A)	41/27/24	42/27/24	42/27/21	46/28/21	46/33/30	46/36/30	49/38/35	51/39/36
	Heating		41/29/26	42/29/26	42/29/23	46/31/24	46/34/30	46/36/30*	50/38/35	51/39/36
Sound Power Level (H/L/Q-Lo)	Cooling	dB(A)	57/43/40	58/43/40	58/43/37	62/44/37	62/49/46	62/52/46	65/54/51	67/55/52
	Heating		57/45/42	58/45/42	58/45/39	62/47/40	62/50/46	62/52/46*	66/54/51	67/55/52
Airflow	Cooling/Heating	L/s	183/193	188/198	188/200	193/202	193/202	208/228	328/338	352/367
Dimensions	Height	mm	290	290	290	290	290	290	295	295
	Width	mm	779	779	779	779	779	779	1,040	1,040
	Depth	mm	209	209	209	209	209	209	244	244
Net Weight	kg		8	8	8	8	8	8	12	13
Refrigerant Pipe Diameter	Liquid Side	mm	ø 6.35	ø 6.35	ø 6.35	ø 6.35	ø 6.35	ø 6.35	ø 6.35	ø 6.35
	Gas Side	mm	ø 9.52	ø 9.52	ø 9.52	ø 9.52	ø 9.52 <sup>1</sup>	ø 9.52 <sup>1</sup>	ø 12.70 <sup>2</sup>	ø 12.70 <sup>2*3</sup>

\*For connection to CU-2252VBR, indoor Sound Pressure Level (Heating) is 46/35/31 and Sound Power Level (Heating) is 62/51/47.

MODEL			MINI CASSETTE WITH nanoe™ X			
			S-25PY3E	S-36PY3E	S-50PY3E	S-60PY3E
Capacity	kW		2.5	3.5	5.0	6.0
Power Source			Single Phase 240V, 50Hz			
Sound Pressure Level (H/L)	Cooling	dB(A)	33/27	36/27	41/29	45/33
	Heating		33/27	36/27	41/29	45/33
Sound Power Level (H)	Cooling	dB(A)	48	51	56	60
	Heating		48	51	56	60
Airflow	Cooling/Heating	L/s	142/142	158/158	200/200	233/233
Dimensions	Height	mm	243	243	243	243
	Width	mm	575	575	575	575
	Depth	mm	575	575	575	575
Net Weight	kg		15	15	15	15
Refrigerant Pipe Diameter	Liquid Side	mm	ø 6.35	ø 6.35	ø 6.35	ø 6.35
	Gas Side	mm	ø 9.52 <sup>1</sup>	ø 9.52 <sup>1</sup>	ø 9.52 <sup>1</sup>	ø 12.70 <sup>2</sup>

\*1 CZ-MA1PA is to be used to reduce the connection size on the indoor unit from 1/2" to 3/8".  
 \*2 CZ-MA2PA is to be used to increase the connection size on the outdoor unit from 3/8" to 1/2".  
 \*3 CZ-MA3PA is to be used to reduce the connection size on the indoor unit from 5/8" to 1/2".



INDOOR UNIT

MODEL			ULTRA SLIM DUCTED				FLOOR CONSOLE		
			CS-Z25UD3RAW	CS-Z35UD3RAW	CS-Z50UD3RAW	CS-Z60UD3RAW	CS-Z25UFRAW	CS-Z35UFRAW	CS-Z50UFRAW
Capacity	kW		2.5	3.5	5.0	6.0	2.5	3.5	5.0
Power Source			Single Phase 240V, 50Hz						
Sound Pressure Level (H/L)	Cooling	dB(A)	35/29	35/28	41/31	43/32	40/27	41/28	46/33
	Heating		36/29	37/29	41/32	43/34	40/27	41/27	48/35
Sound Power Level (H)	Cooling	dB(A)	51	51	57	59	56	57	62
	Heating		52	53	57	59	56	57	64
Airflow	Cooling/Heating	L/s	175/175	187/187	255/255	262/262	163/173	170/182	198/227
Dimensions	Height	mm	200	200	200	200	600	600	600
	Width	mm	750	750	750	750	750	750	750
	Depth	mm	640	640	640	640	207	207	207
Net Weight	kg		19	19	19	19	13	13	13
Refrigerant Pipe Diameter	Liquid Side	mm	ø 6.35	ø 6.35	ø 6.35	ø 6.35	ø 6.35	ø 6.35	ø 6.35
	Gas Side	mm	ø 9.52	ø 9.52	ø 9.52 <sup>1</sup>	ø 12.70 <sup>2</sup>	ø 9.52	ø 9.52	ø 9.52 <sup>1</sup>

OUTDOOR UNIT

MODEL			(50Hz)	CU-Z252VBR	CU-3254VBR	CU-4271VBR	CU-4280VBR	CU-52100VBR
Power Source				Single Phase 240V, 50Hz				
Cooling Operation	Capacity (min-max)	kW		5.20 (1.50-6.00)	5.40 (1.80-7.30)	7.10 (1.90-8.80)	8.00 (2.30-9.20)	10.00 (2.30-11.50)
Maximum Connectable Capacity			kW	7.7	9.5	11.5	14.7	18.3
Maximum Connectable Indoors			Units	2	3	4	4	5
Electrical Data	Running Current	A		5.9	5.1	7.4	8.9	11.8
	Power Input (min-max)	kW		1.35 (0.25-1.62)	1.12 (0.36-2.18)	1.66 (0.34-2.47)	1.98 (0.42-2.87)	2.60 (0.43-3.59)
	AEER/EER	W/W		3.79 / 3.85	4.74 / 4.82	4.23 / 4.28	4.00 / 4.04	3.81 / 3.85
Noise (H)	Sound Pressure Level	dB(A)		51	48	49	51	53
	Sound Power Level	dB(A)		66	62	63	67	69
Heating Operation	Capacity	kW		6.10 (1.10-7.20)	7.00 (1.60-9.00)	8.50 (3.00-10.70)	9.40 (3.00-11.60)	12.00 (3.40-14.50)
Electrical Data	Running Current	A		6.2	6.8	8.6	9.3	12.1
	Power Input (min-max)	kW		1.43 (0.21-1.90)	1.54 (0.32-2.63)	1.95 (0.50-2.72)	2.03 (0.50-3.42)	2.76 (0.58-4.02)
	ACOP/COP	W/W		4.21 / 4.27	4.49 / 4.55	4.32 / 4.36	4.58 / 4.63	4.31 / 4.35
Noise (H)	Sound Pressure Level	dB(A)		53	49	51	52	56
	Sound Power Level	dB(A)		68	63	65	68	72
Maximum Current			A	11.5	15.2	15.6	19.0	21.3
Starting Current			A	6.4	7.0	8.8	9.7	12.5
Compressor Output			W	900	1300	1300	1700	1700
Dimensions	Height	mm		619	795	795	999	999
	Width	mm		824 (+70)	875 (+95)	875 (+95)	940	940
	Depth	mm		299	320	320	340	340
Net Weight			kg	39	71	72	80	81
Power Supply				Outdoor	Outdoor	Outdoor	Outdoor	Outdoor
Pipe Length Range (1 room)			m	3-20	3-25	3-25	3-25	3-25
Maximum Pipe Length (Total) **			m	30	50	60	70	80
Refrigerant Pipe Diameter	Liquid Side	mm		ø 6.35	ø 6.35	ø 6.35	ø 6.35	ø 6.35
	Gas Side	mm		ø 9.52	ø 9.52	ø 9.52	ø 9.52	ø 9.52
Operating Range	Cooling	(°C)		-10~+46	-10~+46	-10~+46	-10~+46	-10~+46
	Heating	(°C)		-15~-+24**	-15~-+24**	-15~-+24**	-15~-+24**	-15~-+24**

\*\* Additional Gas might be required for some models. Refer to Page 32 for information on Additional Gas.

Rating Conditions

	Cooling	Heating
Inside air temperature	27°C DB / 19°C WB	20°C DB
Outside air temperature	35°C DB	7°C DB / 6°C WB

# 2-PIPE Mini-VRF LZ Series

High External Static Pressure  
**35Pa**

## High external static pressure 35Pa

When unit is installed on a narrow balcony and exposed to the sun, the fence at the front side would restrict hot air from being discharged. Heat accumulated in an enclosure can cause over-heating. This could potentially result in damage or shorten the product's life span. A high external static pressure sends the air further away from the outdoor unit and through the fence. This provides better air circulation and distribution.

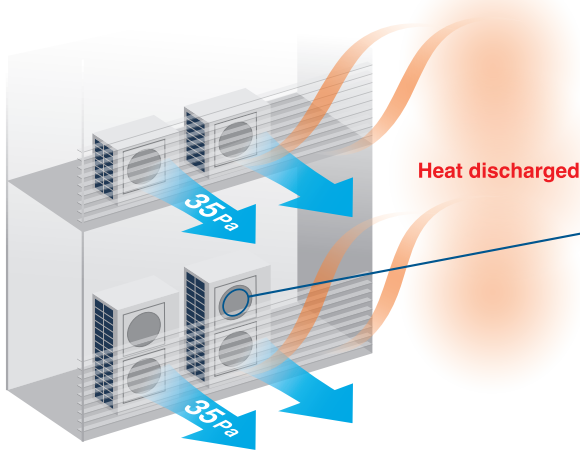

### LZ series - High pressure

But with a high pressure of 35Pa, hot air is sent further away preventing overheating inside the outdoor unit enclosure.

### LZ series fan

The new LE Series fan has ribs extending near the blade tips, in a structure that resists deformation. During high electrostatic pressure, this blade shape suppresses disruptions in the airflow, and a high air pressure of 35 Pa discharges the hot air a sufficient distance.



## Compact design

Also, since Mini VRF LZ Series is a single unit, it is possible to install the unit in more various places compared to the Single Split system.

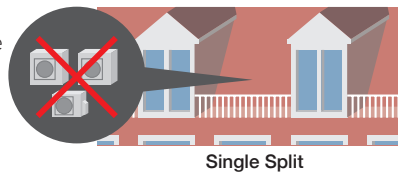

Single Split

Mini-FSV

In addition to raising efficiency, we have made the outdoor unit more compact. It can now be installed in places that were previously too small.

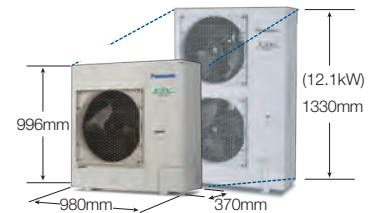
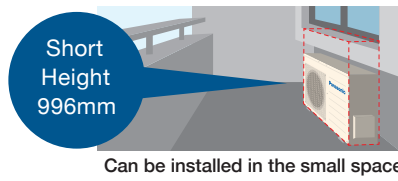

## Long piping design length for greater design flexibility

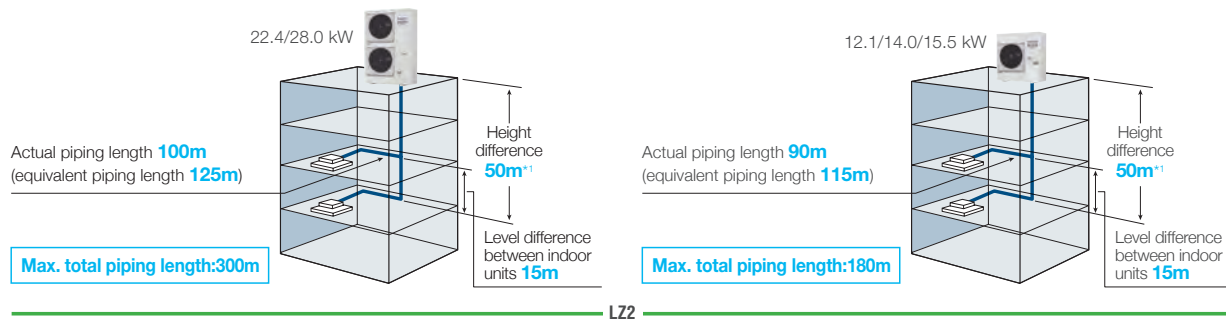

LZ2

\*1: 40m if the outdoor unit is below the indoor unit.

### Blue fin condenser

The anti-corrosion Blue Fin treatment of the heat exchanger provides greater resistance against corrosion. All models are equipped with Blue Fin condenser.

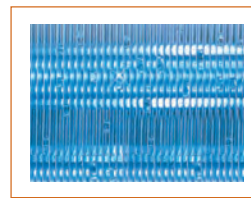

Heat exchanger (blue fin condenser)



[ Rear view ]

### Energy savings design

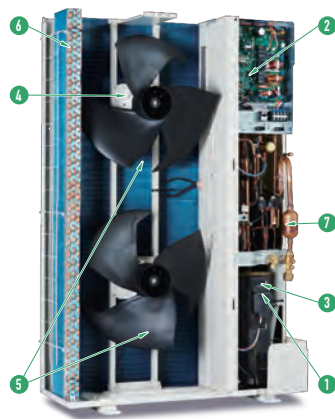

- 1 Panasonic Inverter Compressor** A large-capacity inverter compressor has been adopted. The inverter compressor is superior in performance with improved partial-load capacity.
- 2 Printed Circuit Board** The number of PCB is 2 pieces for making maintenance easier.
- 3 Accumulator** A large accumulator has been adopted to maintain compressor reliability because of the increased refrigerant quantity, which allows an extended max piping length.
- 4 DC Fan Motor** Checking load and outside temperature, the DC motor is controlled for optimum air volume.
- 5 Newly Designed Fan** The newly designed fan blades have been developed to inhibit air turbulence and to increase efficiency. As fan diameter has been increased its size, the air volume has been increased whilst maintaining a same sound level.
- 6 Heat Exchanger & Copper Tubes** The heat exchanger size and the copper tube sizes in the heat exchanger have been redesigned to increase efficiency.
- 7 Oil Separator** A centrifugal separator has been adopted to improve oil separation efficiency and reduce refrigerant pressure loss.

### Wide operating range

- Cooling operation is possible even when outdoor temperature is as low as -10°C DB.
- Cooling operation is possible even when outdoor temperature is as high as 52°C DB. (LZ2 series)
- Heating operation is possible even when outdoor temperature is as low as -20°C WB.

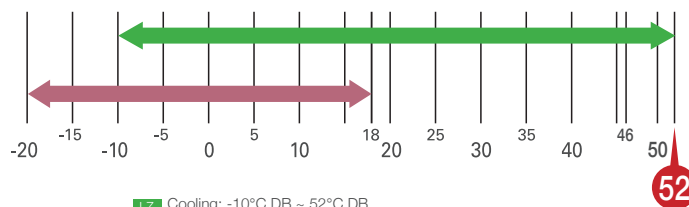

LZ Cooling: -10°C DB ~ 52°C DB  
LZ Heating: -20°C WB ~ 18°C WB

\* For further information please refer to the capacity tables in the Technical Data Book.

The remote controller temperature can be set from 18°C up to 30°C (Cooling), 16°C up to 30°C (Heating)\*1.

\*1 Depending on the type of remote controller.

### Quiet operation mode

- Quiet operation mode reduces outdoor unit operating sound down to 7dB than rating.
- 3-step set point is available.
- External input signal is also available.

\* Timer setting of quiet operation mode is available in High-spec Remote Controller (CZ-RTC5B/CZ-RTC6 series).



### Wide range of connectable indoor units

An expansion from Panasonic VRF line up, the Mini-VRF is compatible with the same indoor units and controls as the rest of the VRF range.

Connecting image

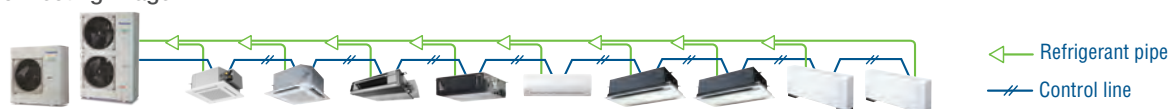

## 2-PIPE Mini-VRF LZ2 Series

kW		12.1		12.1		14.0		14.0		15.5		15.5			
Model name		U-4LZ2E5		U-4LZ2E8		U-5LZ2E5		U-5LZ2E8		U-6LZ2E5		U-6LZ2E8			
Power supply		230/240V/1-phase/50Hz		400/415V/3-phase/50Hz		230/240V/1-phase/50Hz		400/415V/3-phase/50Hz		230/240V/1-phase/50Hz		400/415V/3-phase/50Hz			
Voltage		230V	240V	400V	415V	230V	240V	400V	415V	230V	240V	400V	415V		
Capacity	Cooling	kW	12.1		12.1		14.0		14.0		15.5		15.5		
		BTU/h	41,300		41,300		47,800		47,800		52,900		52,900		
	Heating	kW	12.5		12.5		16.0		16.0		16.5		16.5		
		BTU/h	42,700		42,700		54,600		54,600		56,300		56,300		
EER/COP	Cooling	W/W	4.53		4.53		4.12		4.12		3.88		3.88		
	Heating	W/W	5.27		5.27		4.71		4.71		4.42		4.42		
Dimensions (H/W/D)		mm		996 x 980 x 370		996 x 980 x 370		996 x 980 x 370		996 x 980 x 370		996 x 980 x 370			
Net weight		kg		94		94		94		94		94			
Electrical ratings	Cooling	Running current	A	12.80	12.20	4.15	4.00	16.20	15.50	5.23	5.04	17.70	18.00	6.12	5.89
		Power input	kW	2.67		2.67		3.40		3.40		4.00		4.00	
	Heating	Running current	A	11.40	11.00	3.71	3.58	16.20	15.20	5.22	5.03	17.71	17.00	5.72	5.51
		Power input	kW	2.37		2.37		3.40		3.40		3.73		3.73	
Starting current		A		1		1		1		1		1			
Air flow rate		m <sup>3</sup> /h		4,140		4,140		4,320		4,320		4,440		4,440	
		L/s		1,150		1,150		1,200		1,200		1,233		1,233	
Refrigerant amount at shipment		kg		R32 2.7		R32 2.7		R32 2.7		R32 2.7		R32 2.7			
Piping connection		Gas pipe	mm (inches)	Ø15.88 (Ø5/8)		Ø15.88 (Ø5/8)		Ø15.88 (Ø5/8)		Ø15.88 (Ø5/8)		Ø15.88 (Ø5/8)			
		Liquid pipe	mm (inches)	Ø9.52 (Ø3/8)		Ø9.52 (Ø3/8)		Ø9.52 (Ø3/8)		Ø9.52 (Ø3/8)		Ø9.52 (Ø3/8)			
Ambient temperature operating range				Cooling:-10°CDB~+52°CDB, Heating:-20°CWB~+18°CWB		Cooling:-10°CDB~+52°CDB, Heating:-20°CWB~+18°CWB		Cooling:-10°CDB~+52°CDB, Heating:-20°CWB~+18°CWB		Cooling:-10°CDB~+52°CDB, Heating:-20°CWB~+18°CWB		Cooling:-10°CDB~+52°CDB, Heating:-20°CWB~+18°CWB			
Sound pressure level (Cooling)	Normal mode	dB(A)	52.0		52.0		53.0		53.0		54.0		54.0		
	Silent mode(1/2/3/4)	dB(A)	49.0/47.0/45.0/45.0		49.0/47.0/45.0/45.0		50.0/48.0/46.0/45.0		50.0/48.0/46.0/45.0		51.0/49.0/47.0/45.0		51.0/49.0/47.0/45.0		
Sound power level (Cooling)		Normal mode		dB		69.0		69.0		70.0		70.0		72.0	

Global remarks	Rated conditions:	
	Cooling	Heating
	Indoor air temperature	27°C DB / 19°C WB
	Outdoor air temperature	35°C DB
		7°C DB / 6°C WB

\* These specifications are subject to change without notice.  
 \*\* High durable model (with suffix "E") has same specifications.

### Dimensions

U-4LZ2E5 / U-4LZ2E8

U-5LZ2E5 / U-5LZ2E8

U-6LZ2E5 / U-6LZ2E8

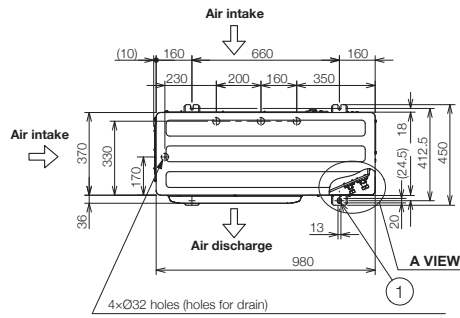

①	Mounting hole (4-R6.5), anchor bolt : M10
②	Refrigerant tubing (liquid tube), flared connection (Ø9.52)
③	Refrigerant tubing (gas tube), flared connection (Ø15.88)
④	Refrigerant tubing port
⑤	Electrical wiring port (Ø13)
⑥	Electrical wiring port (Ø22)
⑦	Electrical wiring port (Ø27)
⑧	Electrical wiring port (Ø35)

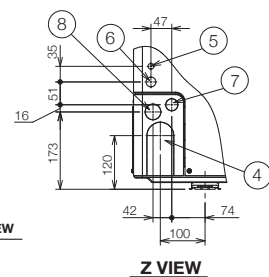
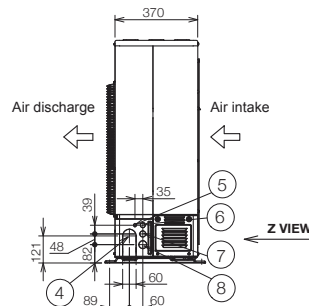
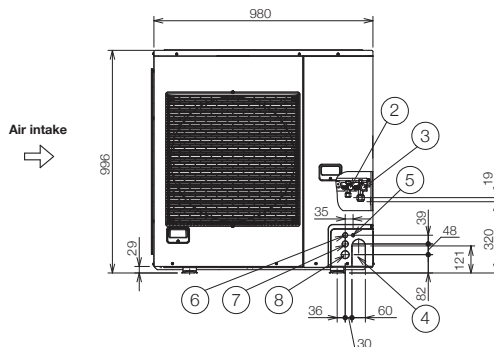
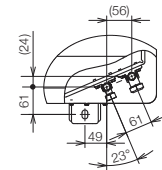

Unit: mm

## 2-PIPE Mini-VRF LZ2 Series

kW		22.4		25.0			
Model name		U-8LZ2E8		U-10LZ2E8			
Power supply		400/415V/3-phase/50Hz					
Voltage		400V	415V	400V	415V		
Capacity	Cooling	kW	22.4	28.0			
		BTU/h	76,500	95,600			
EER/COP	Cooling	W/W	3.84	3.47			
	Heating	W/W	4.30	4.47			
Dimensions (H/W/D)		mm	1,500 x 980 x 370				
Net weight		kg	125				
Electrical ratings	Cooling	Running current	A	9.25	8.91	12.5	12.1
		Power input	kW	5.83		8.07	
	Heating	Running current	A	9.32	8.98	9.93	9.57
		Power input	kW	5.81		6.26	
Starting current		A	1		1		
Air flow rate		m <sup>3</sup> /h	9,480		10,020		
		L/s	2,633		2,783		
Refrigerant amount at shipment		kg	R32 4.9		R32 5.1		
Piping connection	Gas pipe	mm (inches)	Ø19.05 (Ø3/4)		Ø22.22 (Ø7/8)		
	Liquid pipe	mm (inches)	Ø9.52 (Ø3/8)		Ø9.52 (Ø3/8)		
Ambient temperature operating range			Cooling:-10°CDB~+52°CDB, Heating:-20°CWB~+18°CWB		Cooling:-10°CDB~+52°CDB, Heating:-20°CWB~+18°CWB		
Sound pressure level (Cooling)	Normal mode	dB(A)	59.0		60.0		
	Silent mode(1/2/3/4)	dB(A)	56.0/54.0/52.0/50.0		57.0/55.0/53.0/50.0		
Sound power level (Cooling)	Normal mode	dB	72.0		74.0		

Global remarks	Rated conditions:		Cooling	Heating
	Indoor air temperature	27°C DB / 19°C WB	20°C DB	
	Outdoor air temperature	35°C DB	7°C DB / 6°C WB	

\* These specifications are subject to change without notice.  
\*\* High durable model (with suffix "E") has same specifications.

## Dimensions

### U-8LZ2E8 / U-10LZ2E8

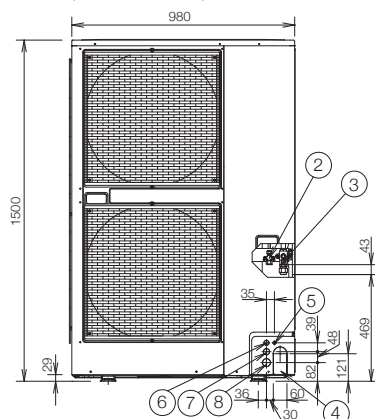
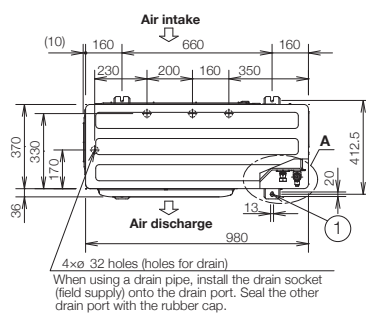

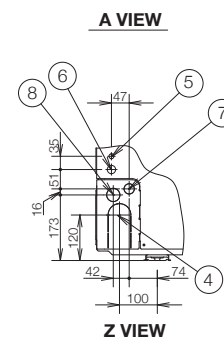
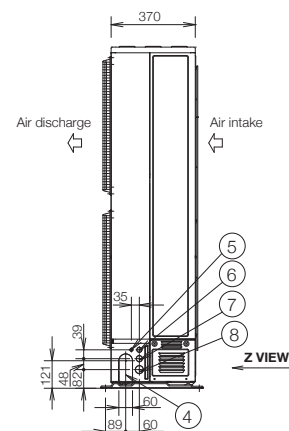
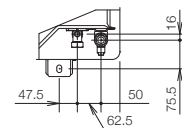

- ① Mounting hole (4-R6.5), anchor bolt : M10
- ② Refrigerant tubing (liquid tube), flared connection (ø9.52)
- ③ Refrigerant tubing (gas tube), flared connection (ø19.05)
- ④ Refrigerant tubing port
- ⑤ Electrical wiring port (ø13)
- ⑥ Electrical wiring port (ø22)
- ⑦ Electrical wiring port (ø27)
- ⑧ Electrical wiring port (ø35)

**For U-10LZ2E8**  
The tubing of the gas main has a diameter of ø22.22, but the connection to the service valve of the outdoor unit has a diameter of ø19.05, so a flare has to be used. Consequently, be sure to use the enclosed joint tube B and joint tube A in making connections (brazing).





















Unit: mm

# Mini VRF Indoor Units

Class	22	28	36	45	56	60	73	90
Capacity								
Type								
kw	2.2/2.5	2.8/3.2	3.6/4.2	4.5/5.0	5.6/6.3	6.0/7.1	7.3/8.0	9.0/10.0
BTU/h	7,500/8,500	9,600/11,000	12,000/14,000	15,000/17,000	19,000/21,000	20,400/24,200	25,000/27,000	30,000/34,000
<b>nanoeX Generator Mark2</b> F3 type <b>ECONAVI</b> Mid Static Adaptive Ducted R410A	 S-22MF3E5A	 S-28MF3E5A	 S-36MF3E5A	 S-45MF3E5A	 S-56MF3E5A	 S-60MF3E5A	 S-73MF3E5A	 S-90MF3E5A
<b>nanoeX Generator Mark2</b> F3 type <b>ECONAVI</b> Mid Static Adaptive Ducted R32	<b>NEW</b>  S-22MF3E5B	<b>NEW</b>  S-28MF3E5B	<b>NEW</b>  S-36MF3E5B	<b>NEW</b>  S-45MF3E5B	<b>NEW</b>  S-56MF3E5B	<b>NEW</b>  S-60MF3E5B	<b>NEW</b>  S-73MF3E5B	<b>NEW</b>  S-90MF3E5B
M1 type <b>ECONAVI</b> Slim Low Static Ducted R410A/R32	 S-22MM1E5B	 S-28MM1E5B	 S-36MM1E5B	 S-45MM1E5B	 S-56MM1E5B			
Z1 type <b>ECONAVI</b> Slim & Narrow Ducted R410A	 S-22MZ1H4A	 S-28MZ1H4A	 S-36MZ1H4A	 S-45MZ1H4A	 S-56MZ1H4A	 S-60MZ1H4A	 S-73MZ1H4A	
E2 type High Static Ducted / Energy Saving High-Fresh Air Ducted R410A								
E1 type High Static Ducted R410A								 S-90ME1R5A
K2 type <b>ECONAVI</b> Wall Mounted R410A/R32	 S-22MK2E5B	 S-28MK2E5B	 S-36MK2E5B	 S-45MK2E5B	 S-56MK2E5B		 S-73MK2E5B	
<b>nanoeX Generator Mark2</b> U2 type <b>ECONAVI</b> ** 4-Way Cassette Panel No. CZ-KPU3H/CZ-KPU3A R410A/R32	 S-22MU2E5B	 S-28MU2E5B	 S-36MU2E5B	 S-45MU2E5B	 S-56MU2E5B	 S-60MU2E5B	 S-73MU2E5B	 S-90MU2E5B
<b>nanoeX Generator Mark3</b> Y3 type <b>ECONAVI</b> 4-Way Mini Cassette Panel No. CZ-KPY4 R410A/R32	<b>NEW</b>  S-22MY3E	<b>NEW</b>  S-28MY3E	<b>NEW</b>  S-36MY3E	<b>NEW</b>  S-45MY3E	<b>NEW</b>  S-56MY3E			
L1 type 2-Way Cassette Panel No. CZ-02KPL2 Panel No. CZ-03KPL2 (Only for S-73ML1E5) R410A	 S-22ML1E5	 S-28ML1E5	 S-36ML1E5	 S-45ML1E5	 S-56ML1E5		 S-73ML1E5	
D1 type 1-Way Cassette Panel No. CZ-KPD2 R410A		 S-28MD1E5	 S-36MD1E5	 S-45MD1E5	 S-56MD1E5		 S-73MD1E5	
T2 type <b>ECONAVI</b> Under Ceiling R410A			 S-36MT2E5A	 S-45MT2E5A	 S-56MT2E5A		 S-73MT2E5A	
<b>nanoeX Generator Mark1</b> G1 type Floor Console R410A	 S-22MG1E5N	 S-28MG1E5N	 S-36MG1E5N	 S-45MG1E5N	 S-56MG1E5N			
P1 type Floor Standing R410A	 S-22MP1E5	 S-28MP1E5	 S-36MP1E5	 S-45MP1E5	 S-56MP1E5		 S-71MP1E5	
R1 type Concealed Floor Standing R410A	 S-22MR1E5	 S-28MR1E5	 S-36MR1E5	 S-45MR1E5	 S-56MR1E5		 S-71MR1E5	

\* High fresh air system is not allowed for 18 kW model. \*\* Only for CZ-KPU3A

106	112	140	160	180	224	280	Functions
Cooling/Heating	Cooling/Heating	Cooling/Heating	Cooling/Heating	Cooling/Heating	Cooling/Heating	Cooling/Heating	
10.6/11.4 36,000/39,000	11.2/12.5 38,200/42,700	14.0/16.0 47,800/54,600	16.0/18.0 54,600/61,500	18.0/20.0 61,400/68,200	22.4/25.0 76,400/85,300	28.0/31.5 95,500/107,500	
 S-106MF3E5A		 S-140MF3E5A	 S-160MF3E5A				self-diagnosing, Auto fan, DRY Dry mode, Auto restart, DP Drain pump, DC motor
<b>NEW</b>  S-106MF3E5B		<b>NEW</b>  S-140MF3E5B	<b>NEW</b>  S-160MF3E5B				self-diagnosing, Auto fan, DRY Dry mode, Auto restart, DP Drain pump, DC motor
							self-diagnosing, Auto fan, DRY Dry mode, Auto restart, DP Drain pump, DC motor
							self-diagnosing, Auto fan, DRY Dry mode, Auto restart, DC motor
				 S-180ME2E5 *	<b>High Fresh Air</b>  S-224ME2E5	<b>High Fresh Air</b>  S-280ME2E5	self-diagnosing, Auto fan, DRY Dry mode, Auto restart, DC motor
	 S-112ME1R5A	 S-140ME1R5A	 S-160ME1R5A				self-diagnosing, Auto fan, DRY Dry mode, Auto restart
 S-106MK2E5B							self-diagnosing, Auto fan, DRY Dry mode, Auto flap, Auto restart, Air Swing
 S-106MU2E5B		 S-140MU2E5B	 S-160MU2E5B				self-diagnosing, Auto fan, DRY Dry mode, Auto flap, Auto restart, Air swing, DP Drain pump, DC motor
							self-diagnosing, Auto fan, DRY Dry mode, Auto flap, Auto restart, Air swing, DP Drain pump, DC motor
							self-diagnosing, Auto fan, DRY Dry mode, Auto flap, Auto restart, Air swing, DP Drain pump, DC motor
							self-diagnosing, Auto fan, DRY Dry mode, Auto flap, Auto restart, Air swing, DP Drain pump
 S-106MT2E5A		 S-140MT2E5A					self-diagnosing, Auto fan, DRY Dry mode, Auto flap, DC motor restart, Air swing
							self-diagnosing, Auto fan, DRY Dry mode, Auto flap, Auto restart, Air swing, DC motor
							self-diagnosing, Auto fan, DRY Dry mode, Auto restart
							self-diagnosing, Auto fan, DRY Dry mode, Auto restart

 Self-diagnosing function
  Automatic fan operation
  DRY Dry mode
  Auto flap control
  Automatic restart function for power failure
  Air swing
  Built-in drain pump
  DC motor



Authorised Dealer

# Panasonic

AIR CONDITIONING

[panasonicaircon.co.nz](http://panasonicaircon.co.nz)

**Panasonic New Zealand Limited** 18 Sir Woolf Fisher Drive, Highbrook, East Tamaki, Auckland 2013, New Zealand  
Phone: 09 272 0100, Fax: 09 272 0134

8315\_BRO-AC-HOME2023